

Prophecies of Melchi-Zedek
in

104-3

THE GREAT PYRAMID
AND
THE SEVEN TEMPLES

by
BROWN LANDONE

Published by
THE BOOK OF GOLD
152 West 42nd St. New York, N. Y.

Generated at University of Chicago on 2022-03-19 18:47 GMT / <https://hdl.handle.net/2027/uiug.30112000012150>
Public domain in the United States; Google-digitized / http://www.hathitrust.org/access_use#pd-us-google

Copyright 1940
The Landone Foundation, Inc.
Orlando—Winter Park, Fla.

PRINTED IN THE UNITED STATES OF AMERICA
AMERICAN BOOK—STRATFORD PRESS, INC., NEW YORK

Generated at University of Chicago on 2022-03-19 18:47 GMT / https://hdl.handle.net/2027/uiug.30112000012150
Public Domain in the United States; Google-digitized / http://www.hathitrust.org/access_use#pd-us-google

133.3
L236p

THE AUTHOR

Brown Landone is Editor-in-Chief of a History of Civilization—the Victories of Scholarship, Science and Art; associate editors were William Hubbard, Edmund Jane James, Daniel Jordan, Lorado Taft, William H. Tolman and John G. Wigmore. In 1909, Doctor Landone was Executive Director of *The New Educational Movement*—an International Committee of 100 noted educators of the United States, Europe and Asia. In 1912 and 1913, he made an *Economic and Financial Survey of the German Empire*. In Paris, prior to 1914, Doctor Landone was Director General of the *Institute of the Sciences of the Arts in France*. Also in collaboration with others in Europe, he helped evolve a draft for a constitution for a United States of Europe, abandoned with 1914 outbreak of war. But lately, as the basis of a plan for a United States of the World, he has written *A Super State with Power to Enforce Peace*. In 1915, by appointment made under authority of Raymond Poincaré, then President of the Republic of France, Dr. Landone was made *Envoyé Special* to the United States representing the friends of France.

For half a century, the Key Temples of Civilization have been studied by Doctor Landone; but neither in this book nor in any other, does he directly reveal the Holy Order of Melchi-Zedek, for no true priest or initiate is permitted to do so. Lately, Dr. Landone was called to associate in the consecration of the New Temple being built in the eastern Andes.

In the science of the arts, beginning in 1898, Dr. Landone studied 153 systems of proportions, and after thirty-eight years of research, he announced in 1936 his *Re-discovery of the Teleois—the Basis of the Canon of Polykleitos*, and key to the true understanding of the *Pythagorean Philosophy of Numbers*.

In peace work, during the first World War, Doctor Landone initiated a movement which reached 90,000,000 people, with messages from the President of the United States, United States Senators, heads of national religious movements, et cetera. In 1939, he founded a movement for peace by prayer and the power of action, namely,—*The Peace Makers*, National Center, Winter Park, Florida.

In economics, after studying the score of 1929-1931 proposals for the remedying of economic conditions, Doctor Landone published in 1932-1933, *The Order of the New Adjustment*.

Brown Landone is by birth a citizen of the United States, but has lived in England, France, Germany and Italy; and traveled widely. He is descendant of the old Lando family of Italy and the Landon family of France. The Italian branch centered at Monza; the French branch at Château Landon, now the oldest château ruin in France. Previous titles of nobility were confirmed by letters patent of Louis XIV. The two oldest French coins, are kept in Musée de Cluny, and bear inscription 'Castra Landonis'. One branch of the French family moved to England, and its Hertfordshire branch added an 'e' to the name. Heraldic shield and crest—three cocks of France and the Plantagenet Red Rose.

A man may be recognized for his work; famed for his hobbies. A radio engineer has written that Doctor Landone has a passion for 'cleaning up things', and decoratively painting walls at night; a railway executive writes Doctor Landone is most interested in living the ideals of which he writes; but probably his greatest hobby is living youthfully. He is perhaps the most continuously working and playing—twenty hours a day—youthful old man of today. Many of his intimate chums are sons and grandsons of former chums. To explain continued youthfulness, Doctor Landone believes that responsiveness of body to spirit, is the one essential.

Doctor Landone is fellow or member of many American and European economic and scientific societies. In addition to his historical works, Doctor Landone is author of many books and monographs. During the war of 1914-1918, assisted by Major-General Leonard Wood, he wrote *Awake USA*; and by permission of the late Theodore Roosevelt, translated into French portions of *The World War*. Some of his other books, are: *The Success Process*; *Desires and Ideals*; *Deep Down in Your Heart*; *The Means Which Guarantee Leadership*, et cetera. Lay sermons of Dr. Landone have been chosen for *Best Sermons of the Year—Book IV* and for *My Idea of God*, edited by Dr. Joseph Fort Newton. Lately, he has written *Soul Catalysts*; *My Joy in Passing On*; *Prophecies of Melchi-Zedek*; and *A Super State with Power to Enforce Peace*.

Robert Collier

THE WORD THAT GOES BEFORE THE PROPHECY

*"He that hath an ear, let him hear what the spirit saith;
"I have chosen you out of the world!"*

*And "Ye have need that one teach you . . . the first principles
of the oracles of God!"*

*"For every high priest taken from among men—is ordained for
man, in things pertaining to God . . .*

*"And no man taketh this honour unto himself—except he that
is called of God . . ."*

*Even the "Christ glorified not himself . . . although he were a
son, yet he learned obedience . . . and being made perfect, he
became the author of eternal salvation . . . an high priest after
the Order of Melchi-Zedek" . . .*

*In this "hope we have as an anchor of the soul, both sure and
steadfast, and which entereth into that within the veil . . ."*

*Whither our "forerunner is . . . made an high priest for ever,
after the Order of Melchi-Zedek!*

*"For this Melchi-Zedek, King of Salem, priest of the most high
God—abideth a priest continually . . . being by interpretation
King of Righteousness, and after that also King of Salem, which
is King of Peace . . . without father, without mother, without
descent, having neither beginning of days, nor end of life; but
made like unto the Son of God!"*

*"He that hath ears, let him hear . . . I have chosen you out of
the world . . .*

"And an oath for confirmation is . . . an end to all strife . . .

*"The Lord hath sworn . . . thou art a priest forever after the
order of Melchi-Zedek."*

TABLE OF CONTENTS

CHAPTER	PAGE
I. Up Out of Dreaded Shadows	1
II. The Path Illumined	6
III. Fateful Day—August NINTH	12
IV. Motor with Me to the Temple	17
V. Who Were the Mysterious Builders?	21
VI. The Teleois in the Pyramid	33
VII. Our Need is Great	35
VIII. Not 'The' Mistaken Dates	36
IX. A Trip to Inner Chambers	39
X. True Names in White Stone	43
XI. Man's Time in Each Temple	45
XII. Have You Ever Foretold the Future?	46
XIII. Wise Men and the Invisible	48
XIV. Prophecies of the Mysterious Teleois	51
XV. Strange Phrases and Numbers	55
XVI. Deeper Meaning of the Temples	58
XVII. Meaning—Hall of Progress	60
XVIII. Meaning—The Great Uplift	63
XIX. Meaning—Altar-Platform	65
XX. Meaning—Hall of Unity	68
XXI. The Vicious War for Gold	72
XXII. Meaning—Temple of Revelation	74
XXIII. Meaning—Hall of Adjustment	78
XXIV. Meaning—Temple of Initiation	79
XXV. Meaning—Hall of Transforming Action	85
XXVI. Meaning—Temple of Transfiguration	86
XXVII. Meaning—Temple of Godhood	92
XXVIII. The Seven Great Powers	94
XXIX. You and Today's Transformation	98
XXX. Seven Temples of Seven Civilizations	116
XXXI. A Holy Day for You	121

APPENDICES

	PAGE
ONE. Antiquity and Culture of Tiahuanacans and Mayas	126
TWO. The Mysterious Disappearance of Khufu and the Unfinished Pyramid	131
THREE. Solar Data in Pyramid	134
FOUR. Davidson's Dates	137
FIVE. Errors of Davidson's Followers	139
SIX. Teleois Numerology	141
SEVEN. Determination of Dates of the Hall of Unity	142
EIGHT. The Gold War, 1921-1933	145
NINE. Action Leadership	156
TEN. Future Dates	159

ILLUSTRATIONS

FIGURE	PAGE
1. Inner Structure of Pyramid	161
2. Great Hall of Progress	162
3. One-Line Dates	163
4. Upper Level Temples	164
5. Hall of Transforming Action	165
6. Temple in the Andes	166
7. Temple of Mystics	167
8. Altar-Platform	168
9. Hall of Unity and the Four World Wars	169
10. Temple of Revelation	170
11. Temple of Initiation	171
12. Time Circles—Floor Level	172

FIGURE	PAGE
A. Teleois Geometrics	173
B. Oil Lamp 'IN' Snowflake	174
C. Teleois Paths of Comets	175
D. Perfection of Skeletal Structure	176
E. Solar System	177
F. Ankle and Foot	178
G. Teleois Perfection in Art	179

UP OUT OF DREADED SHADOWS

When will world strife end? Will there be one more world war? In what year shall we witness the advent of permanent peace on earth?

For many years, the prophecies of world leaders *have been mistaken.*

In strange contrast, the prophecies of the Teleois *have come true!*

Looking o'er earth, man realizes that human guidance has failed him. With millions at war or preparing for war, and plenty and starvation hand in hand, man's soul is confused by the present and doubtful of the future. Yet he still hopes and longs for guidance on which he can depend.

Man's present need is deep and widespread. If we listen as from the stars, we hear tens of millions praying for guidance—longing for light from some dependable source to give us hope and true guidance. Never have so many millions longed for something true in which they can have faith.

What of the future? This is the prophecy: "*When the War of the Conflict of Giants shall merge into the War of the Gehenna of Exhaustion—on that day, shall nations of earth be reborn to a new age; and thou shalt have peace on earth.*" The inner advent of this peace, according to the Teleois of Melchi of Salem, of the Order of the Melchi-Zedek, is to come on or before March 6 of 1947! This is not determined by extremists, but by the greatest mathematicians the world has known, who knew the nature of man's development and his rate of progress on earth. It is determined by the Teleois circles—the basis on which the seven key temples of the seven waves of civilization have been built.

*Past Teleois prophecies of events up to today, even to the day and hour, have come true.*¹ Hence, there is hope that present prophecies of the present and future are reliable. These Teleois

¹ See Chapter III—FATEFUL DAY—"AUGUST NINTH."

proportions² are found in the structure of the solar system—see *Figure E*, in musical scales, in designs inside of snowflakes, in the human skeleton, in geometric forms, in the grain of wood, in time units of earth and sun, catenary of mathematics, et cetera.

Forty-one years of investigation show that the Teleois reveals the proportional structure of the solar system, and its basic movements. The ancient wise men who designed the seven key temples, used it with intention; they knew what it signified, how to use it to measure time and prophesy events of the future.

THE GREAT NECESSITY

In the confusion of today, three facts are certain: we need something on which we can depend; human wisdom has failed us; we are searching for a higher guidance—something more certain than the mistaken wisdom of leaders who have directed world affairs this last quarter century.

Human guidance HAS failed us—individually, economically, internationally. There is reason for this. Man's wisdom and progress, face in opposite directions. Human wisdom cannot be wisdom, except it look backward to past experience. In contrast, man's inner self forever moves him forward into the future. So human wisdom illumines the road backward, but leaves man's path to the future in foggy uncertainty and dreaded shadows.

Wise men of old were prophets, looking forward; their prophecies inspired man onward to attainment. Leaders of today are doubters; and there is no inspiration in them; their guidance leads us backward thousands of years—to a modernized cave-man's existence—underground, with gas masks and darkness and mutual destruction. To save ourselves, we must turn to guidance more spiritual and certain.

The prophecies of our world leaders have been mistaken. Two decades ago, great world leaders prophesied that the war ending in 1918 had made the world safe for democracy, and would give us a century of peace. Ten years later, in 1928, wise industrialists and financiers prophesied another decade of amazing prosperity. More recently, in 1938, three great European leaders prophesied 'peace for our generation.'

And the result of their leadership is tragic. We hear the cry

▪ More is told of the Teleois in this and succeeding chapters.

of tens of millions in want, and the cry of youth³ longing for opportunity; and the cry of young men—wanting laughter and life—being forced to kill and be killed; and the smothered cry of the mothers, silently weeping through the night. The wise leaders of today offer us only more conflict—economic strife and territorial wars, and more destruction—with more want and possible formation of new unions of nations to lead more millions to be engulfed in the horrors of future wars.

Into the shadows, however, comes a light! It is a true vision, with faith in the certainty of its fulfillment. It comes of inspiration, but is proven by science. It lifts us up and restores us; and—by new discoveries of science—it gives us, first, the certainty that divinity exists, even though petty-minded man—concerned with indigestion and securities—may doubt it.

The name given to divinity matters not; there is now scientific proof of its existence and intelligence. Forty thousand billion stars still whirl through trillions of miles of space, proving a divinity intelligent enough to guide them all; a divinity loving enough to keep each moving in perfect harmony with billions of others through millions of years.

And inside of snowflakes, microphotographs reveal the designs of *things which have been invented by man*. Such designs of chairs and hats, ink wells and lamps, and a hundred other things were not painted inside the snowflakes by man! These are designs recorded in snowflakes by infinite intelligence, just as the same designs have been inspired into the mind of man by that same divine intelligence, awakening in man's mind the urge to create them as realities. Such intelligence is certain and sure; it can guide man and nations of men!

WHICH WAY? WHERE?

With man so confused, not knowing what to do, he is asking questions, and wants answers. What can he DO to make life safe and secure and happy? What to expect in the next five years? Can he sanely hope for a beneficial change—for himself and his children a generation hence? Is this the second or THIRD world

³ Criticism of our youth is unjust. In our own country alone, there are 16,000,000 youth, 19 to 29 years old. For ten years, millions of them have never known even one day of sane economic opportunity. At their ages and under similar conditions, we older people might not have been so sane and controlled. The conduct of our youth during the last decade gives us prophetic hope of a new age on earth.

war? *Was there a Second World War, so silently maneuvered that we did not recognize it as war? Will this Third ⁴ World War—the Conflict of the Giant Dictators—merge into a Fourth World War—the Gehenna of Exhaustion—and shall we then attain permanent peace on earth? Peace is promised by the prophecy, but WHEN will peace come? Will it be permanent, or an interlude of a year, or ten years—with more world wars to follow?*

If man is guided aright, he will determine the future rightly. We must not be misled. All people are now linked so closely—by industry and world trade, airplane and radio—that conditions on one continent affect all nations, and affect us. In solving our problems in relation to the world, we must recognize self-evident truths: First, no people can be conquered! Second, deposing a leader will not change a people. Third, every attempt to build up one group against another group, will lead to more wars. Fourth, war can change boundaries, but it cannot change ideals! Fifth, war will henceforth be so devastating that both victor and vanquished will be in a worse condition at the close of a war than at its beginning. Sixth, with conditions worse, not even the ideals for which man fights will be enhanced by the victory, because the unremedied conditions will lead to more wars! Seventh, peace will not come by any ideal or plan of *separating* the peoples of earth; world peace will come only by mutually desired and intended unity—inspired by the spiritual ideal of the brotherhood of all peoples on earth.

THE CLEAR VISION

Such guidance points the way to the brotherhood of man. World leaders of today say that brotherhood is impossible. *The prophets say that the fraternization of men in opposing trenches is evidence that man prefers to be a comrade, rather than to kill.* Which is true, is revealed by what the soldiers have done. Soldiers are taught to obey, and when they disobey orders of their respective high commands, in order to fraternize across no man's land, there is proof of the advent of brotherhood now. Its attainment at this time will fulfill the prophecies of the ages. Those prophecies have come from those ancient wise men who have known the races of man and how they progressed. *They come from those who have foretold what would come true, and whose*

⁴See Chapter XXI, THE VICIOUS WAR FOR GOLD, and Appendix EIGHT.

prophecies have come to pass. They tell us now that the era of brotherhood is here; we have faith that this prophecy is also true.

Dependence on the wisdom of man is leading us to the abyss of *Gehenna*—the hell of destruction!

Dependence on the guidance of the prophets leads us to *Ouranos*—man's heaven on earth.

Prophecy is the channel by which the intelligence of the infinite flows to man and guides him aright. "Receive the prophet in the name of the prophet," and man shall come up out of the shadows.

II

THE PATH ILLUMINED

There IS something, based on proven knowledge, which is sanely prophetic. It is as impersonal as earth and stars; ages old, yet living today in its messages to us. It is the mysterious system of the Teleois, used as a sacred code by all ancient wise men, and lately rediscovered. It was used to transmit knowledge and prophecy from one civilization to another.

ONE recorded message of this Teleois relates to our own time. *It tells of man's present progress and struggles, and also what man must do to establish the reign of abundant plenty and permanent peace on earth, and how it must be done.*

I digress a moment to ask you to study each *Figure* in this book, and to read its accompanying comment before you read further. This will help you particularly to understand the next three subjects: first, the nature and extent of the mysterious Teleois proportions; second, the evidence that its past prophecies have come true; and third, the evidence that one order of ancient wise men designed the seven key temples of the world in which the prophecies are recorded, and that the Pyramid of Gizeh is one of these temples.

THE MYSTERIOUS TELEOIS

The Teleois is a mysterious series of numbers and proportions found—as previously stated—in musical scales, distances of planets from the sun, designs of snowflakes, et cetera. It also determines the structures of all key temples of Palestine and Thibet, ancient Cathay, Mayaland and the eastern Andes. Some of these were built ten thousand miles distant from the others; one was built 7378 years before Christ, and one 798 years after Christ. In the structure of the Pyramid of Gizeh the Teleois is so dominant that we are forced to believe that it was intentionally used to symbolize and record knowledge of the past and prophecies of the future. *But more amazing—these same records were built into the temples of Tiahuanaco 4497 years BEFORE the Pyramid*

was built, and then repeated in the temples of Mayaland, Cathay and Thibet.

The first step in the *rediscovery* of the Teleois of the ancient wise men was made in 1898.

The basal Teleois proportionals are 1, 4 and 7.

The primary Teleois proportionals are 13, 19, 25 and 31.

Secondary Teleois proportionals are 10, 16, 22 and 28.

The subject of the Teleois¹ is here limited to (1) the universal presence of the Teleois and (2) its use in the structural features of the Great Pyramid, as a means of recording knowledge of the past and future. Its extent seems to be universal.

First, it is found in our solar system; the distances of planets and asteroids from the sun, and also from each other, are in Teleois proportions.

Second, in our musical scales, there are 4 determining tones—do, mi, sol, do; there are 7 intervals in the major scale; there are 13 intervals in the true minor scale; and 19 predominating usable musical overtones of each note of the finer musical instruments.

Third, "Perfect proportion of figure means that every part of the body is of a size and form that corresponds to all other parts of the body."² Measurements exact to a millimeter of the standard human skeletons at Cambridge and Harvard and Oxford, reveal that every important skeletal length in the structure of the human body is a Teleois unit in relation to lengths of other structural parts of the same skeleton.

Fourth, every beautiful object or structure of Greek art—vase, sculptured figure, pillar, portico or temple—is in accord with Teleois proportions.

Fifth, all geometric designs which for ages³ have been judged to be sufficiently beautiful to be repeatedly used in building forms and decoration, are formed of Teleois parts or spaces.

Sixth, the holy of holies of every sacred temple on earth was constructed to accord with Teleois proportions.

Seventh, many micro-photographs of snowflakes have now

¹ See two folders—*The Teleois and How to Use the Teleois*, by Brown Landone, Newton, N. J., 10 cents.

² *History of Civilization*, by Brown Landone, Vol. VII, Age of Appreciation, p. 46.

³ Even in the Bronze Age, Teleois "geometrical designs were frequent . . . rectangles of various proportions, and concentric circles." *History of Civilization*, by Brown Landone, Vol. I, The Dawn of Magnificence, p. 68.

been taken. Inside of the hundred or more which have been measured and studied, micro-photography reveals designs of things which are exact patterns of things which man has made. Every dominant part of these designs inside of snowflakes is in Teleois proportion to every other part.

As an example of this, I am having reproduced in this book a photograph of a snowflake which contains a design of an old-fashioned oil lamp. Every part of the lamp design is in Teleois numbers. See *Figure B*.

This fact, even alone by itself, has spiritual significance. Certainly man could not have climbed up into the sky and put such a design inside of a tiny snowflake. Hence, its presence there—and the presence of scores of other such designs inside of snowflakes—is one of the proofs that there is a divinity which impregnates snowflakes—perhaps all things—as well as the mind of man.

All things of nature appear to be created on the basis of the Teleois proportions. Grains of a planed piece of wood are in Teleois proportions; forms of beauty found in the weeds of nature—measured on remarkable photographs⁴—are in Teleois proportions; and masses of cumulative clouds, measured on photographs,⁵ are in Teleois proportions. Also all movement in nature seems to accord with its proportions, such as the movements of trees swaying in the wind.

PROOF OF PROPHECIES

Knowledge determined by the Teleois is exact. Teleois proportions are more exact in representing the distances of planets from the sun than is Bode's Law. Even though the paths of comets⁶ are elliptical and no two the same, yet the width to the length of each major comet's path which has been so studied is a Teleois proportion. Teleois proportions seem to be basic in the universe. That is probably the reason they were used by ancient wise men to transmit their knowledge and prophecies to us.

The *prophecies* of the Teleois have been proven to be certain and true! They have truly revealed events which are now past;

⁴ *Urformen der Kunst*, by Carl Blossfelt.

⁵ *A Travers les Nuages*, by Manfred Curry.

⁶ See Figure 165, p. 413, *Astronomy*, Vol. I, by Russell, Dugan and Stewart.

they are revealing what is happening today; and they apparently foretell events of the future with the same certainty. *They seem to be the most certain guide known—not only in unlocking knowledge of ages past, but in revealing the time of events of the future.*

I wish here to emphasize that these Teleois circles reveal only dates of events of truly great importance in the changing progress of man's life on earth; and that the Teleois circles NEVER predict any such insignificant fact as the rise or fall of prices on a stock market, or personal incidents in the lives of individuals. I have not space here to present the hundreds of prophesied dates of events which have come true. I ask you to consider only a few,—as for example, dates of the World Wars of which you yourself know. These alone give us faith that we *have* apparently found a sane prophetic code on which we can depend.

In early March of 1914, in public talks given at the Sorbonne in Paris, and six weeks later in London, I stated that a great European war would break out within six months, that its advent would be evident before the end of July 1914. Informed officials of Great Britain and France ridiculed my statements, and a high official⁷ of the French Ministry urged me not to repeat them, asserting there would be no general European war for several years. *Yet in five months, all Europe WAS at war!*

The certainty of this knowledge was not of myself; it came from economic surveys based on understanding of the Teleois time-circles built into the solid stone structure of all key temples of the ages—of Tiahuanaco and Cathay, Palestine and Thibet, and the Great Pyramid of Gizeh. Remember, these Teleois proportions are the *same* as those of the solar system, and the same as those of the designs inside of snowflakes.

Then late in 1936—three years *before* 1939—additional study of Teleois circles in the Great Pyramid revealed that great world-changing events would take place in 1939. Some of the prophesied 1939 dates were: August 9, 20-21, 23, 30 and 31; September 1, 3, 20, 27 and 29; October 5, 6, 14 and 16; and November 5, 13, 27, 29 and 30—all of 1939. Other dates in 1937 and 1938, which were designated at the same time, are: in 1937—January

⁷ After the talk at the Sorbonne, an intimate friend in the French Ministry of Marine, called on me next morning before breakfast, to urge me not to repeat such statements as I had made the night before. He insisted that I was mistaken, and that the Secret Services of France and Great Britain knew there would be no general European war for several years.

30 and July 30; and in 1938—March 11, September 21 and 29, November 10, and December 25.

Certified affidavits prove that all of these dates were designated approximately three years before the events of 1939—exactly two years and ten months before August 20 and 21 of 1939, when Germany and Soviet Russia made their non-aggression pact; before September 1 of 1939, when the German armies marched into Poland; before September 3, when Great Britain and France declared themselves at war with Germany; before the September 20 when Germany and Russia agreed on the partition of Poland; before the September 27 when Poland surrendered unconditionally to Germany; before the November 30 when the Russians attacked Finland; et cetera.

4821 YEARS AGO

These dates were not determined by human reasoning. They are revealed by *intersections* of Teleois circles, whose proportions were built into all ancient temples by the wise men—particularly in the Great Pyramid of Gizeh, 4821 years *before* the events came to pass. Just as an expert of plant life—who knows the nature of a plant and its rate of growth—*can* foretell much of the plant's future, so also it seems that ancient wise men who knew the nature of man and the rate of his progress, *could* foretell when man would reach each great developmental change, and when the great events of such changes would take place. These Teleois circles have also revealed with definiteness the time periods of great scientific discoveries, of vast economic changes, of great wars, of transformations or reversals of governmental ideologies, and of great spiritual changes.

With all the world in confusion, and even world leaders completely in the dark as to the future, it inspires the soul to know that there appears to be something so true in the Teleois that it reveals even the time of important events to come. If but one of these prophecies of 4821 years ago had come true, we might expectantly hope for dependable guidance. But when ALL of the prophecies of past events—scores and hundreds of them—HAVE come to pass, we can know the calm of sublime certainty in something which can guide us aright—something on which we can depend.

These prophecies declare that this is the age of transforming action. This is shown by the particular intersections of Teleois

circles and by the way in which their numbers resolve themselves, according to the meanings of the ancient wise men, *from initial cause into action, and then into new forms*. When initial power moves into action, and that action produces NEW forms—then we have transforming changes. Not only spiritually, but on the basis of proven mathematical data, we are told that the period from August 10 of 1939 to March 6 of 1947 is a period in which *the world shall be transformed*. And, by the same data, we are told that *the advent of permanent peace shall come on or before March 6 of 1947*. —

The path is illumined.

“O Soul of faith, sublimely strong in all things great—
Why dost thou let thy petty changing mind make doubts
of little things?
All doubt is of the mind’s ideas, which are forever changing,
and rechanged each hour.
But faith is of soul—the very *substance* of all things, and
hence eternal as the stars.”⁸

⁸ *Deep Down in Your Heart*, by Brown Landone, p. 218.

III

FATEFUL DAY—'AUGUST NINTH'

The day of August NINTH of 1939 was a fateful day! In looking back to that date, the day may not at first seem important to us, for we have thought more of the particular days when German troops marched into Poland and Russian forces attacked Finland. But 4821 years ago, mystic wise men indicated that to them August ninth would be THE day of 1939. And when we learn what did take place on that day, we realize that the mystic wise men were more concerned with inner causal changes which initiate a series of great events, than with the subsequent events due to that inner cause.

There is definite record of the citation of these dates *before* the events took place. In Minneapolis in Minnesota, during the second and third weeks of June 1939, I was giving two public talks daily for ten days. Approximately the same audience of 250 people attended each of these talks. June 20 and 21, stereopticon slides were used to illustrate the dominance of the Teleois proportions in snowflake designs, in the solar system, and in the structure of the Great Pyramid of Gizeh. In both talks—June 20 and 21—August NINTH of 1939 was particularly emphasized as THE day during which something would be done or some decision made—so important that its results would rock the world! On the same days in June, attention was called to other Teleois circles of the Pyramid, which indicated when other important world events would take place—see Chapter II.

The next week—June 27 and 28, 1939—talks were given to audiences in Canada in the Royal York Hotel in Toronto, and in the Royal Connaught Hotel in Hamilton. During these talks, I twice emphatically stated that August ninth would be THE day when either secret or open action or decisions would be made, of such importance that the results might change the maps of Europe and Asia and Africa, and perhaps change all modern civilization. Please understand, I do NOT assume that these circles always indicate the nature of what will happen; they mainly reveal the time when great changes will come. They do

this by the time basis of the cubic structure of the temples and the proportions of its Teleois circles.

REVEALED IN 1936

The date of August 9, 1939, and all dates given in Chapter II—and many others—were worked out by calculations in late September and early October of 1936—approximately *three years before* the war events of 1939. I had studied the temples of the seven civilizations, including the Great Pyramid, for more than fifty years. But after the advent of the First World War in 1914, I had been occupied with so many other matters during and after that war, that after 1918 I had given little additional study to the Teleois circles in the great temples, until 1936.

Then, in July of 1936, I began receiving scores of letters, asking about a world change which the followers of Davidson prophesied would be *amazing*, and would take place at midnight of September 16, 1936. Some of them also prophesied that 1938 and 1939 would be a “*time to cheer our hearts*”!

Of course, in answering those letters, it was necessary for me to state that those prophecies were fantastically wrong! And that **NOTHING** of importance would happen on September 16, 1936, because the *basis* of Davidson's dates was mistaken. See *Figure 3* and comment. It was those letters which impelled me at that time again to take up the study of the Teleois circles of the Pyramid and other temples. That study in 1936 revealed the significance of the NINTH of August of 1939.

WHAT IS THE EVIDENCE?

August ninth of 1939 is **THE** day on which Hitler made the primal decision which determined when the Third World War¹ should begin in Europe; on that day secret arrangements for co-operation were made and methods of war were determined. At direction of Hitler, Germany's Foreign Minister, von Ribbentrop, had previously taken up residence near Salzburg, half an hour's automobile drive from the Hitler tower at Berchtesgaden. Some of the conferences of that fateful August ninth were held in von Ribbentrop's summer residence; others at Berchtesgaden.

¹ That this was the day when the decision was made, was later made public by Count Ciano in his speech of December 16, 1939.

THE FATEFUL DAY

The following ALL took place during ONE fateful day—the day of August 9, 1939:

August 9, 12:40 A.M., Hitler received Forster of Danzig, and gave him directions as to when and how to initiate union of Danzig with Germany.

August 9, early morning, Forster left; flew to Danzig.

August 9, 12:45 A.M., Hitler himself personally telephoned Berlin, instructing that newspapers launch a renewed, ultra-violent attack against Poland, that morning.

August 9, Berlin morning newspapers carried headlines demanding "Danzig or War."

August 9, 1:30 A.M., Hitler secretly conferred with Stalin's unnamed envoy; this envoy had arrived at midnight by plane from Moscow.

Please note that on this day of days, the conferences mentioned above took place before two o'clock in the morning. Other conferences continued until daybreak, then through the day, and up to midnight—twenty-four continuous hours of conferences by Hitler. Other conferences and events of that day of fate are listed below:

August 9, forenoon, Hungary's Foreign Minister, Casky, conferred with von Ribbentrop near Salzburg.

August 9, forenoon, Hitler told envoy of Yugoslavia what supplies he demanded from that country, and asked for military alliance with Yugoslavia.

August 9, Yugoslavia's envoy rushed for additional conference with von Ribbentrop.

August 9, within an hour, envoy of Yugoslavia excitedly left Salzburg; hastened to communicate by long distance telephone with Yugoslavian Premier in his own country.

August 9, immediately afterward, about noon, Yugoslavia's Premier 'indefinitely' suspended all negotiations with Matchek, the pro-Nazi Croat leader in Yugoslavia.

August 9, 2 P.M., Premier of Yugoslavia announced that he would fly to Venice and Rome the next day.

August 9, 4 P.M., same Premier telephoned Hitler, refusing military alliance with Germany.

August 9, Yugoslavia gave order to rush fortification on its German frontier. Yugoslavia also decreed storing of food for army and civilian population.

August 9, Prince Paul of Yugoslavia communicated by wireless with King Carol of Rumania, who was on his yacht on a private vacation cruise.

August 9, King Carol started at once to return to Bucharest.

August 9, by wireless, Premier of Rumania was ordered by King Carol to return to capital; all Rumanian Ministers were commanded not to leave Bucharest.

August 9, Monsieur Herriot, President of French Chamber of Deputies, cancelled his planned visit to the United States.

August 9, King of Belgians secretly communicated with Kings of Norway, Sweden and Denmark.

August 9, 9:30 P.M., another envoy from Soviet Russia not previously known to have remained at Berchtesgaden, was hurriedly driven to von Ribbentrop's, and telephoned Stalin in Moscow.

August 9, 10:30 P.M., special envoy of King of Bulgaria left von Ribbentrop's for conference with Hitler at Berchtesgaden.

August 9, Germany took over Czech forests.

August 9, 11:00 P.M., Russian envoy received telephone message from Stalin; envoy took airplane for Moscow.

August 9, one German submarine fleet was ordered to establish base at Cueta, Northern Africa; another at Murmansk, Northern Russia.

August 9, German Field Marshal Goering returned to Berlin after 25-day tour of Germany.

August 9, Field Marshal of German Army announced, "Germany has an iron-ore reserve for more than 100 years."

August 9, Hitler ordered every theatre to show films depicting Germany's 'invincible' Western Fortification.

August 9, Director of German secret agents in Poland ordered to report personally to Hitler.

August 9, 11:45 P.M., Premier of Yugoslavia postponed visit to Rome.

August 9, Germany mobilized mechanized army on Moravian-Slovak frontier.

August 9, *Germany ordered ALL of its citizens from 5 to 70 years of age to register for basic service in war time.*

Thirty world important conferences or activities in twenty-four hours! In that time, during the day of August 9, 1939, Hitler is reported to have been at his desk for twenty-three hours.

It was the fateful day of August ninth! *One of the decisive days of the century.*

From all that did happen on that day, it seems evident *that the ancient wise men of Melchi-Zedek—who designed all the great holy temples of all civilizations—were able to foretell man's progress, and that they have left hidden within the Teleois something on which we can depend for guidance.*

With all the world in confusion, with human guidance failing us, with grave economic problems unsolved, with no one knowing just what to do, with millions unable to decide what is best for the future, with the prospect of one world war following another—with all these conditions, it lifts the heart and inspires the soul to know that there IS a spiritual basis on which we may build a sane faith, and accept the prophecy that the good for which man is striving will be initiated by 1947.

“Have faith; let not thy mind disturb thy soul!
But rather lead thy mind to know thy faith.
Then both with courage shall be fortified.”²

² *Deep Down in Your Heart*, by Brown Landone, p. 218.

IV

MOTOR WITH ME TO THE TEMPLE

Imagine that you are in Egypt with me, in Cairo. Early some morning, or at night—I prefer the night, when Egyptian skies are jeweled—we motor out of the city to the west, crossing the Nile by the Bulaq Bridge. Within ten miles, we come to the edge of a slightly elevated, flat limestone ledge, which juts out of the desert.

Here we see only a few pyramids now, but once—3500 years ago—there were more than three dozen, built on this elevated land, probably because it provided a solid base. All but one were burial tombs, with inner walls carved and chiseled to record inscriptions, telling of the greatness of the pharaoh or noble buried within. The Sphinx is here also—mighty, mysterious, eternally calm as the stars.

ONE of the pyramids is larger than the others. It is called the *Great Pyramid*, or the *Pyramid of Gizeh*. It was built to proportions different from those of all other structures in Egypt, and the unit of measurement used was the Sacred Egyptian Cubit. In all other structures in all of Egypt, the Royal Cubit was employed.

As you will later learn, the most amazing feature of the Great Pyramid is its particularization of the seven key temples of the seven civilizations of man, so that its structural sequence is like a library of man's essential attainments in each civilization, disclosing also the nature of our present civilization, and man's rate of progress at present and in the future.

IS IT COINCIDENCE?

The similarity of proportions and the symbolism of two great structures—built thousands of years apart in time—might be considered to be coincidence. But the use of the same proportions and symbols in more than *ninety* temples of seven different civilizations—some built thousands of years before Christ, others only recently—can NOT be coincidence. Then also, one finds

twenty-two proportions and mathematical formulæ in the Great Pyramid. These are the *same* as those of a temple built at least 4497 years *before* the Great Pyramid was built, and also another temple built 3679 years *after* the Pyramid of Gizeh was built; and the same proportionals have the same meanings in all the temples. It seems evident that the Great Pyramid was designed by a group of ancient wise men who had knowledge of the past and clear vision of the future, and that this Brotherhood of Wise Men passed on their mystic knowledge from civilization to civilization.

To reveal to you the wisdom and prophecies which the wise men built into all these temples, I could use the proportions of any one of them. This, however, would require many pages to describe such temples. So, since the Pyramid of Gizeh is still standing, and its exact measurements are widely known, I am using it.

MIRRORS FIVE ACRES LARGE

The form of a pyramid is like a pile of dirt, except that its base is not round, but usually four-sided. You may be disappointed when you first see the Great Pyramid, because it is now only a brownish-grayish mass. When first built, 4821 years ago,¹ its outside surfaces were finished with beautifully polished white stone—so perfectly and marvelously curved slightly inward, that each side was like a slightly concave reflecting mirror. The area of each mirror side was more than five acres. These mirrors converged the sun's rays; and angles of its shadows told of changes from season to season. At that time, the Great Pyramid was a gigantic hourglass of earth and sun! Today, all outside white stone covering is gone. Its sides are great dark-colored stone ledges—each set back from the layer or course below, so that they form great stone steps.

THE ENDURING TEMPLE

As we come nearer the Pyramid, you realize more of its immensity and majesty, and disappointment vanishes. Every other structure—built anywhere in the world at the time the Pyramid was constructed—is now in ruins or has completely disappeared.

¹ It took 13 years to build it.

Egyptians built solidly, always on the basis of three dimensions—usually the cube. Hence, they “left a history of achievement in works² . . . greater and more lasting than any other works of ancient time.” The Pyramid is still the greatest true building on earth. Its base covers land equal in area to five city blocks of usual size.

The stones used are enormous. Outer stones weigh from two to six tons—some heavier; a few in the inner structure, thirty tons. Some writers have been rather careless and inexact in statements about the amount of stone in the Pyramid, yet the true facts are amazing. By best mathematical estimate, the building contains approximately 90 million cubic feet of stone.

As we look up its sides, you will probably wonder if I shall ask you to climb to the top, from one ledge to another. Most of these steps are more than two feet high, and the first one, more than four feet. Of course the writer who states that ‘thousands’ of these outside stones are as tall as the average man, exaggerates. That is about as true, as saying that thousands of college students are eight feet tall!

BUILT TO SUN AND STARS

Other facts about the outside astound us. It was built to the measurement of Pyramid inches. There are 25 Pyramid inches to each Sacred Egyptian Cubit. The length of the base of each side of the Pyramid is 9131.05 Pyramid inches. To change this into Pyramid cubits, you divide the 9131.05 inches by 25. The result is the length of each side of the Pyramid in Sacred Egyptian Cubits. Divide 9131.05 by 25, and the answer is 365.2422—the exact length of each side in cubits. This number is exactly the same as the number of days in our solar year—even to a tiny part of a second! This Pyramid is built to accord also with Teleois proportions. It reveals not only the time movements of our earth around our sun, but the time it takes for our entire universe to whirl around its center³—3,233,000,000,000 miles away.

Strange as these facts are, they are not of practical importance to us today, unless we find in them something of guidance—

² *History of Civilization*, by Brown Landone, Vol. I, The Dawn of Magnificence, p. 130.

³ The Pleiades. See *The Pageant of the Stars*, by Willem J. Luyten, pp. 213, 220.

something which will guide us in the tragic times through which we are passing—revealing the nature of world changes of today, and how long the period will last, and what we may expect in the near future.

Within the Pyramid, no tomb and no provision for a tomb have yet been discovered. The west half—the part we now know—IS a temple and a Temple of Temples. Most pyramids built as tombs have but one main chamber each. But in the Great Pyramid there are thirteen passageways and temples. In a subsequent chapter, we shall go inside, and visit these chambers. In these chambers, mystic masters of ages ago built into the stone structure, records of knowledge and prophecies to guide us today! They embodied their knowledge in temples of all civilizations and summed it up in chambers of the Great Pyramid. This is guidance on which man CAN depend, so that he can attain the goal.

PERSONAL GUIDANCE

When you later read the first chapter of the Meanings of Halls and Temples, you at once realize that this guidance IS also personally helpful. The first inner temple—the Hall of Progress—convinces even the doubter. It teaches that *expansion* is the first step of all growth and attainment—expansion of mind, of soul, of activity; and that you do not develop by repetition, but by expansion into new activities. No matter what your individual problem, the first step in changing it, is *expansion* of your soul and your activities—out of what has been, into what you desire. Expanding one's activities, is like coming up out of a cellar, to live under the expanse of stars!

This first revelation of the Hall of Progress is guidance on which you can depend. This teaching that expansion is the first step, is spiritual truth—the same that is revealed in the first chapter of Genesis. Look in the *Revised Version* of your Bible, margin of the first chapter of Genesis. You find that 'heavens' means *heaved-up* or *expansion*—the result of the *first power* God used in creation!

This reveals the helpfulness and practicality of the knowledge and prophecies of the ancient wise men. And just as *expansion* is revealed as the keynote of the Hall of Progress, so for today—1939 to 1947—the Pyramid reveals that the keynote of our progress today, is *great transforming change!*

WHO WERE THE MYSTERIOUS BUILDERS?

It seems incredible that one group of builders could have continued building for 9301 years. Yet their work proves they did. They built sacred temples—of the same proportions, same symbols, same mathematical significance and spiritual meanings—from 7378 years B.C. to 1923 A.D. This is the more amazing when we realize that no modern European nation is yet 900 years old!

WHO carried on such work? Who built the key temples of Tiahuanaco and Cathay, of Mayaland and Eleusis, of Thibet and ancient Egypt? WHO built the Great Pyramid of Gizeh?

The Egyptians were great builders, yet all historical and archeological evidence makes it certain that they themselves did not design this particular Pyramid. No other pyramid in Egypt is like the Great Pyramid. No other Egyptian pyramid is built by measurement of the Sacred Egyptian Cubit, or to proportions of the Teleois. No other Egyptian pyramid reveals knowledge of earth and sun movements, and exact mathematical formulae. Such knowledge was not known even to the highest priests of ancient Egypt. Every essential feature of the Great Pyramid, except its outside form, is found in NO other building of any kind in Egypt. The Egyptians could not have built the Great Pyramid.

Either *Assyrians* or men of the *Far East* have been suggested as the builders of the Great Pyramid, by some ill-informed writers. But at the time the Pyramid was built, all orientals and peoples as far west as Assyria,¹ “knew as little of perspective as they did of mechanics”, and in drawing, they “frequently combined . . . a vertical section with a projection.” Such people could *not* have built the Pyramid. *Phoenicians* and *Israelites* have also been assumed to have been the builders. But the building attainments of these countries, center around four cities—Jerusalem, Sidon, Tyre and Carthage—from 1300 to 850 B.C. The Pyra-

¹ *History of Civilization*, by Brown Landone, Vol. I, Dawn of Magnificence, p. 210.

mid was built 1500 years *before* the earliest of these.² *Holy Men of Thibet* are assumed by other writers, to have sent builders to Egypt nearly 5000 years ago, to build the Pyramid of Gizeh. But NO one can believe this assumption *unless* he is very ignorant of the time when the holy centers in Thibet were first established.

HOLY MEN OF THIBET

Wisely to judge whether these people, or the priests of Thibet, built the Great Pyramid, you should know when the Holy Men first went to Thibet, and when they first built temples. The first holy men went to Thibet only 900 years before Columbus discovered America. And NO holy temple of any kind existed in Thibet, until nearly 800 years *after* the birth of Christ. Great spiritual changes have *lately* taken place in Thibet. Recent books reveal conditions which did not exist even forty years ago in the Temples of Thibet or in the lives of their holy men. One author, a free-minded airman, tells of conditions very different from those of fifty years ago. Another writer, one of the first Caucasians initiated into Thibetan priesthood, proclaims the beauty of the truth into which he was initiated, and truly reports what he saw and experienced, all *after* 1930. So he portrays the life in the Thibetan temples as it is today, and he does not realize how different it is from the life of the holy mystics in years past. Since he had never visited Thibet until a few years ago, he did not recognize the change which had taken place twenty years before he went there. His description of women in the sacred temples and many other conditions, show how greatly all the essentials of Thibetan holy life have changed. The monks and priests of Thibet once formed the holiest celibate brotherhood in the world.

WHEN HOLY MEN LEFT

Because of the changes in the lower orders of priests, and because the holiest men realized that the new surge of war over Asia will last for centuries, the *Holiest of the Holy Men left the holy city of Lhassa in 1922, never to return!* They had always lived apart from the thousands of lower priests and monks in the temples and monasteries. These holiest men left Thibet to return

² *History of Civilization*, by Brown Landone, Vol. I, Dawn of Magnificence, p. 244.

to the eastern Andes, to re-establish their holy center there. Their predecessors had left this same east Andean center thousands of years ago, to journey north, then to Cathay, and finally to Thibet. The return of these holiest men to the sacred heights of the eastern Andes may be called the holy fulfillment of a sacred circle—a recognition of a great world transformation. These Holiest of Holy Men have decreed that the present and coming *ideal* civilization, shall be centered in the Americas.

These holy men of Thibet could *not* have sent men from Thibet to build the Pyramid of Gizeh, because there were no holy men in Thibet until 3473 years *after* the building of the Pyramid, and the holy temples in Thibet were not started until 3679 years *after* the Pyramid was closed and sealed.

And how is this related to the building of the Great Pyramid? The inner structure of that pyramid embodies essential proportions which had been built into the Andean Temple of the God in Gold and in the Caracol³ of the Mayas.⁴ And the same proportions were later built into the Eleusinian Temples, the Holy of Holies, and the Temples of Lhasa in Thibet.

Now consider the time factor: The Temple of the God in Gold was built at least 4497 years *before* the Pyramid was built, and the first temple in Thibet was not built until 3679 years *after* the Great Pyramid was under construction. It might have been mystics of the Andes who built the Pyramid of Gizeh, but it could NOT have been the Holy Men of Thibet.

HYKSOS DESTROYERS

Were the *Hyksos* the builders? Davidson and his followers seem to desire to prove that the Hyksos did build the Great Pyramid. It is true that, "after the last of the great twelfth dynasty rulers, we find these shepherd kings, the Hyksos, *calling* themselves Kings of Egypt".⁵ The first Hyksos invaded Egypt about 1765 B.C. They did not conquer the Delta section, so they could make themselves rulers until about 1670 B.C. They ruled only 100 years

³ *Maya Architecture*, by George Oakley Tatten, pp. 102-103.

⁴ These are, by evidence, much older than modern archeologists assume them to be. See Appendix ONE, *Antiquity and Culture of the Tiahuanacans and Mayas*.

⁵ *History of Civilization*, by Brown Landone, Vol. I, Dawn of Magnificence, p. 142.

before they were driven out—"100 years ⁶ is ample for the whole period".

Davidson and his followers call the Hyksos "the great building race". It is difficult to understand such a statement, except as a mere creation of the imagination. There is NO evidence of any kind which even suggests that they were builders, and there is abundant historical and archeological evidence that the Hyksos built nothing of importance, and left no great monuments or buildings of their own. Even the nature of these Hyksos ⁷ kings makes it evident that they were not builders. The Hyksos are noted for two things: they *levied heavy taxes*, and kept all they collected, and second, *they were destroyers*, they destroyed monument after monument, temple after temple.

The Hyksos destroyed so much, that after they were driven out, it took the true Egyptian kings 200 years to restore ⁸ that which the Hyksos had destroyed. Inscriptions in temples and on obelisks erected by Queen Hatshepsut provide abundant historical evidence of the great work she did to restore that which had been destroyed by the Hyksos. So the *nature* of the Hyksos, who built nothing and destroyed much, makes it impossible to believe that they were the builders of the most amazing structure of all time.

Then also there is evidence of historical dates which proves the Hyksos could not have built the Great Pyramid. Historians and archeologists agree that the Great Pyramid was built between 3080 B.C. and 2690 B.C. The exact mid-year of the actual building work is 2881 B.C. The Pyramid was finished in 2875 B.C., two years after Khufu died. The Pyramid was completed at least 1100 years BEFORE the first Hyksos began their invasion of Egypt.

KHUFU THE MYSTERIOUS

Another factor of evidence is the date of Khufu's reign. It coincides with the period during which Egyptologists, historians and archeologists agree that the Great Pyramid was built. There are five pyramids in the Great Pyramid group. The other four are

⁶ *A History of Egypt*, by James Henry Breasted, p. 221.

⁷ It was once assumed that the word Hyksos meant *shepherd*, because one part of the word means *crude*, and cultured Egyptians called shepherds *crude*-men. We now know, however, that while one part of the word does mean *crude*—the other part means *king-robbers of the people*.

⁸ *A History of Egypt*, by James Henry Breasted, pp. 217, 222, 267, 280.

tombs and monuments of members and nobles of the Khufu dynasty. ALL these pyramids were built of stone from the Khufu quarries; the Great Pyramid contains Khufu stones, chiseled and marked with the name Khufu. All these larger pyramids were built for the Khufu kings who lived 1100 years before the Hyksos came to Egypt.

The chambers of the Pyramid now opened were never intended as a tomb, yet historical evidence proves it was built to be a monument to Khufu the Great. Each Egyptian ruler built his own tomb-temple or monument while he lived. Khufu reigned from 2900 B.C. to 2877 B.C. Khufu built a mortuary temple⁹ at the east base of the Great Pyramid. This was built on the broad pavement of the Pyramid itself, so that Khufu's funeral services would be held at its base. There is evidence of a hidden passage from this mortuary of Khufu on the Pyramid's eastern pavement, extending underground and up into the eastern part of the Great Pyramid. Please note that all the chambers now known are in the western half of the Pyramid. Nothing has as yet been opened in the eastern part. See Appendix TWO—*The Mysterious Disappearance of Khufu and the Unfinished Pyramid*.

Knowing the nature of the Hyksos who built nothing and destroyed much, it is difficult to believe that they 'loved' Khufu so much that they used the money they collected by taxing the subject peoples—for building the greatest structure of the ages, and that they built it to honor Khufu! It seems still more fantastic for Davidson and his followers to believe the Hyksos built a funeral temple at the base of the Great Pyramid for a funeral service for Khufu, 1250 years *after he had died!* All evidence—historical, archeological and structural—proves that the Hyksos had nothing whatsoever to do with the concept, design or building of the Great Pyramid.

And lastly, did the Tiahuanacans build the Pyramid? These ancient people, and the Tiajurans before them, lived in the *eastern* Andes, over the mountains from what is now southern Peru. They reached magnificent heights of culture thousands of years before the beginnings of Greece and Rome; long before the civilizations of Mayaland, Egypt and Thibet. Of "almost¹⁰ inconceivable" antiquity, they were "hoary with age¹¹ when the Pyramids of Egypt and Ur of the Chaldees were young."

⁹ *A History of Egypt*, by James Henry Breasted, p. 119.

¹⁰ *Old Civilizations of the New World*, by A. Hyatt Verrill, p. 56.

¹¹ *Ancient Andean Life*, by Edgar Lee Hewett, p. 263.

The Mayas were not the earliest peoples in America, but to learn of ancient placement of buildings—for the Pyramid was also marvelously placed—let us consider the Mayas first. Their high priests possessed remarkable astronomical knowledge, and it is amazing that they could calculate the incidence of the sun's rays for any moment of any day, and for each particular location, so exactly that they were able to orient placement of their temples so that, on a chosen day, at the exact moment of high noon, no shadow was cast on any side of the building—not even a fraction of a part of an inch of a shadow.

Thousands of years before, the ancient Tiajurans—who preceded the Tiahuanacans, who in turn preceded the Incas of Peru—attained a perfection in building greater than that ever attained by any people before or since their time. While many mathematical, astronomical and symbolic features of the very ancient temples of these people are found in the Great Pyramid, yet it seems they did not build it, for the east Andean builders were on the decline—hoary with age—long before the Pyramid of Gizeh was built.

THE MYSTIC ORDER

Structural evidence is the most dependable evidence in helping us to discover who did build the Great Pyramid of Gizeh. The proportions of the holy room of the Tiajurans' great Temple of the God-in-Gold, its spiritual symbols, mathematical and astronomical data—all were the same as those of the Temple of Heaven in ancient Cathay, of the Temples of Eleusis, of the Caracol in Mayaland, of the Holy of Holies in Jerusalem, and of holy temples in Thibet, and the Great Pyramid. Even though one of the earliest of these temples was built 4497 years *before* the Pyramid, and the latest 3679 years *after* the Pyramid, yet all contain the same essential features.

These facts indicate that there has been and is a great Order of Mystics who—for thousands of years—have possessed a remarkable knowledge of astronomy and mathematics and building—as well as knowledge of the *nature* of man and the *time-rate* of his progress on earth—and that mystic wise men of this order built facts they knew into the structure of each key temple of each great civilization; and that they designed the Pyramid of Gizeh also.

RECORDS IN HOLY THIBET

The FIRST evidence of this is the fact that the only recorded data of the design of the Pyramid are not found in Egypt or Africa, but in treasured scraps of very old manuscripts, in the sacred libraries of the Masters of Thibet. These give dimensions and designs, and even instructions for the building, as well as the meaning of the symbolism of the Pyramid. There was no modern knowledge of these facts, until the Pyramid was reopened in the last century. Since there were no temples in Thibet until 3679 years after the Pyramid was built, and since its exact measurements were known in Thibet centuries before there was any modern knowledge of the Pyramid, these manuscript scraps must have come from some ancient source. Some Holy Order must have kept them somewhere and preserved them for at least 3673 years, from the time the Pyramid was sealed until the first temple was built in Thibet!

THE MYSTERY STONE

SECOND, the measured sizes of *sides* of great stones excavated in the high eastern Andes, repeated in the Great Pyramid 4497 years later, indicate that some Order of Mystics carried on that knowledge. One of the stones of one of these ancient Andean temples is the most amazing stone known on earth today. To reveal the significance of this, I take space here to tell you a little about how those great stones were fitted together in building the Tiajuran and Tiahuanacan temples. These people built differently from any other race or civilization. They did not square stones and lay them in courses, as our masons lay bricks, or as the Egyptians laid the stone of their Pyramids.

The Tiahuanacans, and the Tiajurans before them, built more marvelously. They cut and tooled stones in irregular forms,¹² to fit in place with other irregular stones. This was done with such mathematical exactness, that when the great stones—some of them twenty times as large as the stones of the Great Pyramid—were lifted and put into place, they wedged each other together. No mortar was needed—only wedges of silver and gold. "Interlocking

¹² See *Ancient Andean Life*, by Edgar Lee Hewett, p. 259; *Ancient Civilizations of the Andes*, by Philip Ainsworth Means, p. 127; and *Old Civilizations of the New World*, by A. Hyatt Verrill, p. 303.

of the blocks¹³ was so perfectly done that no earthquake could have the least effect."

One of these great stones has 32 slanting sides! The area of one side is exactly 103.033 square units—this is the number of Pyramid inches of the height of the lower part of the west wall of the Temple of Initiation in the Pyramid; and it is also the length of the side of a square whose area equals that of a circle bounded by a circumference of 365.2422 units—that is, equal to the number of days of our solar year. Another side of this great stone has an area, the square root of which is 116.26. In linear units, this 116.26 is the diameter of the circle whose circumference exactly contacts the north and south walls of the middle temples of the Pyramid; then also, it is the diameter of a circle whose area is equal to that of a square whose side is 103.033.

These two amazing mathematical facts—of the relation of square to circle—indicate a close link-up between the builders of the Great Pyramid and the builders of ancient Tiajuran and Tiahuanacan civilizations.

The area of another side of this same 32-sided stone is 182.62—that is the same as the height of the south side of the Temple of Mystics of the Pyramid—one-half the days of our solar year, 365.2422 days. Still another area is a square root of 25,827.5—the number of years of the precession of the equinoxes. See Appendix THREE—*Solar Data in Pyramid*. Then one end of this great stone is marked into seven areas. These areas are seven proportionals of 1, 4, 7, 13, 19, 25, 31. All of these are *Teleois*. In addition, nineteen other sides of this stone of the ancient civilization of the Andes, give exact measurements used 4497 years later in the Pyramid of Gizeh in Egypt.

One can no longer doubt that some great Order of Mystic Wise men, possessing astounding knowledge of mathematics and astronomy, had something to do with the designing of the temples of Tiajura and Tiahuanaco, and the Great Pyramid, and all other key temples of other civilizations in which similar data are found.

BOSS AND VISION LINES

THIRD, the form of the Boss in the Temple of Revelation of the Great Pyramid is found in exactly the same form in the Tibetan Temple of Temples in Lhassa; in the Great Gold Shield

¹³ *Ancient Andean Life*, by Edgar Lee Hewett, p. 259.

of the Temple of the Sun-in-Gold in the Andes; and it was used in four parts in the Holy of Holies in Jerusalem!

FOURTH, the same Teleois proportions are found, not only in the Great Pyramid, but in the Eleusinian Temples, the Temple of Heaven in China, Caracol of the Mayas, Holy of Holies in Jerusalem, and in the inner circle of the Andean Temple of the God-in-Gold!

FIFTH, the evidence of the *angle of vision lines* is so strange that it mystifies us. It depends not only on mathematics but also on physiology and psychology. It is the angle formed by the line of the level of the eye of man and the line of vision from man's eye to the Sacred Boss—at the moment when he enters the great Thibetan Holy of Holies and first sees the Boss. This angle of the vision line is the same, when one first straightens up on entering the Temple of Revelation in the Great Pyramid, and sees its Boss. The same angle determined the vision line from the south entrance to the Sacred Shield in the Inner Circle of the Temple of the God-in-Gold.

SIXTH, there is the evidence that the priests and people of each civilization did NOT possess the knowledge cited above, although it IS found in their sacred key temples.

THE UN-NAMEABLE

SEVENTH; the most amazing evidence of all is that ONE great symbol of peace and power found in all key temples. It is the *Mel-chi-Ze-dek Symbol of the Seven Powers of God*. No matter what the name of God in any civilization, this symbol is always the same. It is the symbol of the *seven powers*¹⁴ by which all things are created—the seven powers by which man attains the highest.

Few records exist of the name, and then only by briefest men-

¹⁴ In the first chapter of our Bible, the word translated God is *Elohim*. This is *plural*, meaning powers of God. In our Bible, these powers are defined by the seven days of creation. Each civilization has given them different names. To the early Christians, the "First is the great Expanding Power of spirit—the Ouranian Power, which Jesus later called the Heaven within. The second is the Resurrecting Power. Third, Conforming Power. Fourth, Cathayan or Purifying Power. Fifth, Harmonizing or Shamean Power. Sixth, Re-creative Power, which re-creates new atoms, new stars, new cells in the body, and man himself. The seventh is the great Actualizing Power of this age—beginning the completion of man's attainment here on earth."—*Spiritual Responsiveness of the Body*, by Brown Landone, L-I, p. 4.

tion. By strange corruption of Arabic and Babylonian signs, it appears as Mel-Chi-Ze-Dek in our sacred literature. The truer ancient name was Mel-Chi of Sa-Lem, as revealed in Hebrews 7:3. The ancient Tiahuanacans called it Tia-Tiaua-Tia. Usually, it was only a symbol of the Un-Nameable! Names can not convey the power of this great mystic Master Spirit of the ages. Since each part of a letter of ancient languages had a meaning, it would take a long sentence to express this name fully in our language. As used in one temple at point of initial consecration, it might be translated: Supreme Holy Master Lord of all High Priests of the Most High God, and King of Power of Uprightness and King of Peace on Earth.

One writer mistakenly thinks that he has proved that the Order of Melchi-Zedek did not build the Great Pyramid, because Melchi-Zedek himself was not a "man" in the flesh. That fact is, however, THE reason why we should believe—for nothing but some Holy Order, guided by such a Master Spirit, could have had access to ALL the knowledge that is recorded in ALL the key temples of earth.

It is certain that the Great Pyramid was planned by holy advisors to Khufu, to be in part a monument to him, but also to be a temple of temples, which by its structure would embody records of the knowledge and prophecies of all key temples on earth.

MELCHI of ZEDEK

One order of holy wise men have carried on the same building work for 9301 years, and designed all the great temples of all civilizations, under the Mastership of the Great Spiritual Entity—called Tia-Tiaua-Tia, and Melchi-Zedek, and Melchi-Salem—*whose sacred symbol has been enshrined in each key temple of each civilization. From the beginning of creation, it is the holiest of the holy, composed of the highest of High Priests of the Most High God—an order so great that the holy seers and great prophets of each civilization have been initiates—an order so spiritual that Jesus Himself was fitted for His work on earth by initiation into the Order of Melchi-Zedek.*

FOUR-FOLD GOD

That which is *complete* in its perfection is holy. Too long we have neglected the complete truth—the *holy* truth—revealed in

our Sacred Scriptures—please read Hebrews 5:5-6, 6:19-20 and 7:1-3.

Adon El-ohim, the one God, who gives us the *law*.

Ya-sha Mish-chah, the Savior Christ, who gives us *love*, saves us by love, and proclaims that all law is fulfilled by love of God and love of fellow man.

Hagion Pneuma, the Holy Spirit, who inspires and transforms and transfigures all *life*.

Mel-chi Ze-dek, the King of Power and King of Peace, who is sent to give us the *peace* that comes of holy power, and the *power* which comes only of holy peace.

It is he, Mel-chi Ze-dek, of whom and by whom the Christ was ordained High Priest of the Most High God! He it is, Mel-chi Ze-dek, who is "*made like unto the Son of God,*" *eternal*, "*having neither beginning of days, nor end of life!*" He it is who is created, first, Melchi of Zedek, which being interpreted is King of Uprighteous Power; and second, Melchi of Salem, which being interpreted is King of Peace!

This is the most neglected truth of all our Sacred Scriptures! Too long we have forgotten him. Millions who long for peace and power within the soul, know him not. Millions who pray for peace on earth, have never prayed to God in the name of his King of Peace on earth—created from the beginning to bring peace to earth, by the Order of the Priests of the Most High God! *We have neglected him! Hence, we have wars! And there is no peace!*

MELCHI of SALEM

Someday Christianity will awaken. And you will awaken, and the world will awaken! *Will it be before March 1947?*

"Ye have need that one teach you again, which are the first principles of the *oracles* of God." Ye have great need now, of knowing the eternal Melchi-Zedek—Master of High Priests of the Most High God—made like unto the Son! They who doubt Him are servants of the works against the Uplifted One; they who deny Him, curse only themselves unto their own destruction—as has happened to one who shouted denial of Him during the last month, while this was being written; *but they who believe in Him and serve Him, become priests of power and peace on earth!*

He it was, who was created by God in the beginning—"without father, without mother, without descent, having neither begin-

ning of days nor end of life; but made like unto the Son of God!"
Created by God to be eternal, and ordained by God to abide continually—the *KING of Power and the KING of Peace on Earth, forever!*

Live unto *God*, and thou shalt know the joy of living by the *law*, righteously!

Live unto *Christ*, and thy fellow men shall *love* thee, and brother thee!

Live unto the *Holy Spirit*, and thou shalt be *inspired* and lifted up and transformed!

Live unto the *Eternal King of Power and King of Peace*, and
THOU SHALT HAVE POWER AND PEACE ON EARTH!

VI

THE TELEOIS IN THE PYRAMID

The Teleois in the Pyramid reveals conditions today, and what man must do to transform himself, in order to enter the great temple on March 7, 1947. Remember the *basal* Teleois—1, 4, 7; *primals*—13, 19, 25, 31; and *secondaries*—10, 16, 22, 28.

On the Gizeh plateau, *outside* the Pyramid, there are 4 dominant structures, and 7 other secondary groups of buildings and tomb plots. *Within* the Pyramid there are 4 main chambers, 4 horizontal passages, 4 inclined floors, 7 dominant levels, 7 low passages, and 13 exits and entrances. *Certainly, all this may be a matter of coincidence.*

The Egyptians did not use our present inch or foot, yet the *crude* approximates of heights of passages and halls and temples of the Pyramid are in Teleois numbers: Ascending Passage 4 feet; Temple of Initiation 13 feet; Temple of the Mystics 16 feet; Temple of Transfiguration 19 feet; Great Hall of Progress 28 feet; Temple of Godhood 31 feet. *That all of these are Teleois, may also be a matter of coincidence.*

But there is other mathematical proof so certain it can *not* be due to coincidence. For example, I use but one chamber here. The proportion of height to length, of the Hall of Transforming Action, is, as 13 to 31. The height is 42.368807 inches; length, is 101.033309 inches; the Teleois key is 3.259139. Divide the height by the key, and the answer is exactly THIRTEEN! Divide the length by the key, and the answer is exactly THIRTY-ONE! Both 13 and 31 are Teleois, and the proportion is exact to the millionth of an inch! *This can NOT be coincidence.*

Hundreds of other Teleois proportions in the Pyramid—equally exact—cannot be due to coincidence! For example, in Temple of the Mystics, inner ridge of roof is a 13 Teleois distance from the floor of Hall of Transformation; and a 19 Teleois from Boss in Temple of Revelation; and its floor level is a 31 Teleois from ceiling of Temple of Initiation—13, 19, 31.

The Teleois circles of space, based on the cubic spaces of halls and temples of the Pyramid, contact and intersect each other in

Teleois proportions. These points of intersection give the time *dates* of great events of the past and present and future. Their exactness in revealing dates of events of our own time, indicates that they are a very definite means of guidance for us.

In my long life, here, I have learned much of many civilizations, and something of seemingly incredible mysteries. But no other thing I have to this time discovered, is so amazingly certain as the Teleois; it is as certain as the stars; its proportions appear to measure the form and distances and even movements of everything—from the minor details of the structure of the human foot and ankle, to the spacing and movements of stars of the universe. This Teleois was known to the ancient wise men; it is found in all their temples; and from it we have guidance not only for individual man, but for nations, and for the world.

VII

OUR NEED IS GREAT

1940
At hour of this writing, half of all people of Europe and Asia are at war, and all earth is chilled by the horror of war!

THREE TIMES by prophesied vision, man has been given opportunity of transforming his life on earth. Once 4821 years ago; once 1911 years ago; once 1142 years ago! Today the vision and the prophetic help and the opportunity have come again. This time we must accept the prophesied help, or civilization will be submerged for 3040 years.

In the Temple of Temples, we find the prophecy, that the world would begin a Great Transforming Change in 1939—NOT so much scientific, or philosophic, as **SPIRITUAL!** It is the prophecy of a transformation to be effected by idealized action—a change which will bring age-long desires into actuality.

Between August 9 of 1939 and March 6 of 1947, man must learn that, without action, the highest ideal is but a soul desire, dying unborn. Our need is great! Shall we accept the guidance offered?

VIII

NOT 'THE' MISTAKEN DATES

My heart has no desire to question any work of anyone.

But faith today is too important to be dimmed by error—particularly when world conditions are so tragic! And truth DEMANDS that any mistake which lessens man's faith shall be corrected.

So I emphatically state, that the dates given in this book are NOT the mistaken and misinterpreted dates given by writers and lecturers on the message of the Great Pyramid. Certainly, I can NOT accept their prophecies that 1938 and 1939—Czechoslovakia and Poland and Finland—were years to keep “our hearts cheered.” And I can NOT accept their previous prophecy that the world was transformingly changed at midnight September 16, 1936—because no such change took place. Neither can I accept their *later excuse* that the world was transformed that night, but that we shall know nothing of it for seven years! Moreover, that change did not take place in 1936, because it will not take place until near March 6, 1947.

These mistaken prophecies are from followers of Davidson, to whom I give great credit for his mathematical and astronomical data. Such work crowns any man's life with merited renown. *But his dates and prophecies are mistaken, and the excuses made for the errors are lessening man's faith!*

Davidson's dates and prophecies are *based on one-line measurements only!* Yet the mystic wise men built the Pyramid on the three-dimension basis, and always symbolized their wisdom by such three-line dimensions. Their use of *cubic spaces* can not be truly interpreted by Davidson's one-line lengths! Let me make the difference clearer: If a string is exactly 12 inches long, I will accept your statement of the fact of its length. But if you tell me, that that string is exactly the same as a 12-inch cubic chunk of ice, I will lose faith in you. Please see *Figure 3*. It is true that, in the case of the war of 1914–1918, Davidson's dates are almost exact, because of a phenomenal feature of the structure of that

particular passage, which makes it 'happen to fit' in with Davidson's time scale. See Appendix FOUR—*Davidson's Dates*.

ANOTHER CAUSE OF MISTAKEN DATES

A second major cause of Davidson's mistakes is his *own* 'adjustment' of the date of the creation of Adam.

From one particular point to another, there is a 4000-inch floor distance in the Pyramid. Davidson emphasizes this fact. So IF one of those points should be used to represent the creation of Adam, and the other the birth of Christ, and IF the creation of Adam took place exactly (?) 4000 years before the birth of Christ—then the 4000 inches and the 4000 years would *fit* each other in number. Davidson, however, knew that remarkable civilizations had existed on earth long before 4000 B.C. He himself writes of these civilizations, and describes a calendar which was in use 241 years *before* Davidson's date of the creation of Adam!

Adam was either the first of mankind on earth, or he was not. If 4000 B.C. represents the date of creation of Adam as the first man on earth, there could not have been civilized races of men, evolving through thousands of years, before the creation of Adam. And if Adam was created more than 4000 years before Christ, then Davidson's 4000 inches and 4000 years would not fit each other!

DID DAVIDSON CREATE ADAM?

Davidson did create a *second* creation of Adam. He calls it the creation of the Adamic race, and places the date of his second creation at *exactly* 4000 B.C. Hence, the 4000 inches of floor length in the pyramid exactly 'fits' the 4000 years from the date of Davidson's creation of the Adamic race to the birth of Christ. See Appendix FIVE—*Errors of Davidson's Followers*.

THE STRUCTURE IS TRUE

No matter what the errors of man, the marvelous structure of the Pyramid itself is true in its clear delineations of the thirteen great eons of man's advancement, by seven great processes. It reveals amazing knowledge of mathematics and astronomy, of each of the seven key temples of seven civilizations, including that of our own age!

If this marvelous structure is rightly interpreted, it will reveal truth on which we CAN depend—both for the spiritual guidance of the individual, and for the practical guidance of man during world changes. The time-periods given in this book are based on the three dimensions of the cubic spaces of the Pyramid, and its dates are based on the Teleois proportions. Of the facts of structure and measurements we are certain. So, after you learn a little more of inner structure of the Pyramid, let us discover if we have any scientific basis for believing that the ancient wise men who designed this great mystic structure could foretell the future!

IX

A TRIP TO INNER CHAMBERS

You have already made a motor trip with me from Cairo to the Great Pyramid to view the outside. Now let us go inside. We walk around to the north side, where there is an opening—about as far above the ground as the top of a five-story house. The great projections of the layers of stones of the outside walls, form what may be called steps.

Some of these steps are more than half your height. Years ago, I often climbed and was half pulled up these ledges. Now we go up to the entrance by means of a ladder stair. After entering, we begin walking down an inclined floor. It runs slantingly downward for about 92 feet. This walk is tiresome—you are bent almost double; you have to stoop, or crawl, for this passage is less than four feet high.

There is something amazing about the slant of this floor. It points outward and to the north! Which reminds me that a stairway in the Holy Room of the Monastery of Ganden in Thibet rises at the same angle and leads to the north; and that the steps from the outer north wall down to the outer court of the Temple in Jerusalem once descended at the same angle.

ONE THOUSAND TRILLION MILES AWAY

The strange feature of this first passage in the Pyramid, is that an imaginary line extended from the middle of this passage outward from the Pyramid—exactly parallel to the floor—points, through 1,764,000,000,000 miles of space, to the exact point where the North Star was 4821 years ago, when the Pyramid was built.

Continuing down this passage about 90 feet, we come to a granite plug at the entrance of another passage, which runs upward on a slant. This plug was put in when the Pyramid was built. It is just a little larger than the passage; hence to remove it, a great section of all the north side of the Pyramid would have to be torn away. The builders knew what they were doing;

once this block was in place, no one could get in, or out. Man has drilled and chiseled and cut a passage around this plug. When we crawl around it, we enter a long *ascending* passage. Again we have to walk bent almost double again, or else crawl, for approximately 128 feet, slanting upward.

Then, all at once, we can straighten up and stand upright! We have crawled into the north end of the Great Hall of Progress! It is magnificent—three times as high as your own living room, floor and ceiling slanting upward; and as long as five 30-foot rooms. But directly in front of us, there is another low passage. It leads *under* the floor of the Great Hall—on a *horizontal* level—to a temple which is built at the very core or axis of the Pyramid. We would not have seen this passage, if the first part of the floor of the Great Hall had not been removed. See *Figure 2*.

TEMPLE OF THE MYSTICS

Along this low horizontal passage, we again have to stoop or crawl, until we reach a temple called the Temple of the Mystics. It was given this name because its structure contains the key to all the proportions used in all parts of the Pyramid; and the number of cubic units of its space is the same as the total number of years symbolized by all the Halls and Temples of the Pyramid which represent man's progress. Mistakenly, this Temple has been called the Queen's Chamber and even the Jews' Chamber. Both these names are ridiculous! The height of the side walls, and the design of the west wall, show that it is a Temple of the Days of the Sun; also a Temple of Life—containing designs for four other temples to be built 1331, 1869, 3679 and 4804 years respectively, *after* the Pyramid was built.

GREAT HALL OF PROGRESS

We now retrace our steps—or rather our crawl—through the low passage back to that Great Hall which we entered when we first came up out of the first Ascending Passage. This Great Hall of Progress—of Man's Attainment through many centuries—is a marvelous structure. See *Figure 2*. In height and length, it is the largest chamber of the Pyramid. You need help to climb up to its floor, but once you are on it, you can walk upright, with great space above you and before. The slanting floor—about 150 feet long—continues upward. It is majestic; and its structure—all sides and floor and ceiling—reveals Teleois symbols of 4, 7, 13, 19, 31.

About five feet in front of the far end of this Great Hall of Progress, we come to a low wall built up vertically from the floor to a height of three feet. From its top the floor continues for five feet, no longer slanting upward, but horizontally. The three feet of the vertical wall have been called the Great Step, as the symbol of the *Great Uplift of Man*. By a little ladder, we climb to the flat top and can stand on *The Great Platform*. If for a moment we turn around, to look back in the direction from which we have come, we look out and downward along the entire length of the magnificently inspiring Great Hall of Progress.

But in front, in the direction we have been going, there are other passages and temples—all on a horizontal level. See *Figure 4*. And please note, in moving from one passage or chamber to another, we have been going from the north toward the south. This is mystically significant. *Many teachers of occultism are never initiated into the mystery of this*. They still think the east is the mystic direction. It is NOT! It is the north! Read Ezekiel 8:16-18 for the curse upon those who turn their backs to the north, and on the young men who face to the east.

To proceed, we now have to stoop again, to pass through the *Hall of Unity*. It is less than four feet high; not so wide as it is high; and only a little less than four and a half feet long. When we come out of it, we enter a very sacred Temple chamber—very peculiar in size, only about 20 inches long from north to south; yet more than 12 feet high.

ENTER THIS TEMPLE ALONE

This is the Temple of Revelation. It is the shrine of the mystic symbol of the divinity of life. The very short length of this Temple—only about 20 inches—*compels each soul allowed to see this sacred symbol, to see it alone and only when alone!* You and I could not stand up, one in front of the other, in this Temple! And we cannot enter it or get out of it, side by side. If we should squeeze up in it side by side, neither one of us would ever be able to stoop enough to get out.

When you stand alone in this Temple and look slightly upward—lifting your eyes to the exact angle **man's eyes are lifted**, when conscious of inspiration—you look directly at the Boss, the most sacred symbol used by mystics of all ages. Of its deeper meaning, I tell you later. Here, I write only of its mathematical significance. It is so designed that—to 1/100,000 of an inch—it

reveals the key to the system of measurements used in the structure of the Great Pyramid, and unifies that system with the decimal system, and then unifies both with Teleois proportions. The only three perfect numerical systems in one! In addition, it defines the Pyramid inch and the number of inches in the *sacred* Egyptian cubit.

This sacred symbol itself is on a granite block, which was shoved into grooves in the side walls before the ceiling of the temple was put in place. In fact, this block forms the south wall of the Temple. There is an open space above and below it. The block itself is about sixteen inches thick. To proceed, we now stoop again to pass under the block. This passage is *The Hall of Adjustment*. Next, we enter the great *Temple of Initiation*. This is sometimes called the second part of the Entrance Chamber. It is grooved on both sides, evidently prepared for other granite blocks like the one under which we have just passed. Here again the ceiling is more than 12 feet high—and as we enter, the space in front of us is almost 7 feet. And directly in front, the stone of the south wall is cut so that it appears to be three great tinted stone veils hanging down some 9 feet long before us.

WHERE MAN IS NOW

Leaving this Temple, we stoop again, to pass through a hall about eight feet long. This is the *Hall of Transforming Action*. Its significance is evident in the transforming changes taking place in the world today. As we come out of this hall, we enter a great temple—the *Temple of Transfiguration*. Years ago this was mistakenly named the King's Chamber. In reality this Temple chamber reveals the ultimate attainments of man, the transfiguration into that for which man has longed during all the ages. *In this man reaches out beyond himself to unify his consciousness with that of the universe.*

This is the last chamber now opened. The length of this Temple is used as one of the factors to symbolize man's *attainment of that which approaches the infinite*. Here special number symbols are used. They are not on the time factor of the days it takes our earth to circle around our sun. Instead, symbols are here based on the great time unit of 25,875.5 years—the time it takes for our entire universe to circle around its great super-sun center.

In subsequent chapters I tell you more of each of these Halls and Temples—their true names, time periods and meaning.

X

TRUE NAMES IN WHITE STONE

The truths revealed by the Great Pyramid become clearer, if you know the true names of passages and chambers, as designated in the treasured scraps of the pre-Masoudi manuscripts, now kept in the Monastery of Drepung, and also in Lhasa in Thibet. The names you have known—such as Jews' Chamber, King's Chamber, et cetera—were mistakenly given to parts of the Pyramid 70 to 80 years ago, and are very misleading.

First, there are the Descending and Ascending Passages.

Second, *The Temple of the Mystics* is the true name of the chamber at the center of the Pyramid—mistakenly called Queen's Chamber.

Third, *The Great Hall of Progress* is the name of the chamber previously called Grand Gallery.

Fourth, *The Great Uplift* is the true name of what was once called the Great Step.

Fifth, *The Altar-Platform of Aetheric Consciousness* is the flat top of the Great Uplift. The name may at first seem strange, until you realize that most of man's initial understanding of the *etheric* nature of matter and of the universe was revealed to him when on this platform.

Sixth, *The Hall of Unity* is the name of the chamber which has been *very mistakenly* called the War Passage.

Seventh, *The Temple of Revelation* is the name of the chamber which enshrines the Sacred Boss.

Eighth, *The Hall of Adjustment* is the name of the passage underneath the Granite Leaf.

Ninth, *The Temple of Initiation* is the name of what has been called the Second Entrance Chamber.

Tenth, *The Temple of Transfiguration*, as designated in the Holy Lhasa records, is the name to be used—instead of King's Chamber—for the last Temple now opened.

THE UNKNOWN TEMPLE

I am not writing now of the superstructure over this last Temple, or of that secretly hidden Temple of Godhood which man's eye has not seen for more than 4817 years—that is, the Temple which has not yet been opened. It is the Temple which should be opened before March 6, 1997. In memory and imagination and inner vision, recall this trip often, so that you shall remember the order in which one chamber follows another. This is important in guiding you to attain your ideals—for you must progress in that same order, from one step of attainment to another.

This is according to the wisdom of Melchi-Zedek, and is guidance on which you can depend. Learn the names of the temples, and fix their *sequence* in your mind—from Progress to Unity of Action, then to Revelation, to Adjustment, to Initiation, to Transforming Action, and then on March 6, 1947—when you shall be responsive enough to be ready to leave all things of the past—to Transfiguration.

XI

MAN'S TIME IN EACH TEMPLE

The time periods—and beginning and ending dates—of each of the Halls and Temples of the Great Pyramid are determined by three factors—mathematically exact in calculation to 1/10,000 of an inch: cubic space of the Hall or Temple; Teleois proportions of chamber; and length of vision lines.

In the Great Hall of Progress, the time approximates 23,632 years, extending from 21,785 B.C. to the 64th day of 1847 A.D.

The Great Uplift, 36 years—from March 6 of 1847 to January 2 of 1883.

Altar-Platform, approximately 31 $\frac{1}{5}$ years—from January 3 of 1883 to June 27 of 1914.

Hall of Unity, approximately 4 $\frac{5}{9}$ years—from June 28 of 1914 to January 12 of 1919.

Temple of Revelation, approximately 10 $\frac{7}{9}$ years—from January 13 of 1919 to October 21 of 1929.

Hall of Adjustment, approximately 11 $\frac{1}{2}$ years—from October 22 of 1929 to May 5 of 1931.

Temple of Initiation, approximately 8 $\frac{2}{9}$ years—from May 6 of 1931 to August 9 of 1939.

Hall of Transforming Action, approximately 7 $\frac{1}{2}$ years—from August 10 of 1939 to March 6 of 1947.

Temple of Transfiguration, approximately 53 $\frac{7}{9}$ years—from March 7 of 1947 to November 22 of 2000.

Temple of Godhood, exactly 103.032997 anomalistic years—from November 23, 2000 A.D., onward.

This is more than a mere series of dates. The comparative length of time of a Hall or Temple is a spiritual symbol of the degree of consecration and effort to be given to the particular process of attainment symbolized by that Hall or Temple. Also, mere length of a Hall or Temple is not so important as its space and height. For example, the length of the Temple of Revelation is very short, but its height is great. This means that often great *uplift* of spirit transcends mere movement forward. Motoring up a steep mountainside, you do not make great progress forward, but you attain heights of great vision. In each Hall or Temple there is guidance of eternal wisdom for you!

XII

HAVE YOU EVER FORETOLD THE FUTURE?

Can anyone prophesy the future with certainty? Is it possible? Can YOU foretell anything before it happens? If you can, then you must admit that others may have the same capacity. If you know the nature of conditions which determine the changes of anything, and if you also know the *time* rate of such changes, you CAN prophesy what will soon take place.

If, in a walled-in driveway wide enough for but one automobile, you see two cars twenty feet apart rushing head-on toward each other at a speed of seventy miles an hour, CAN you—or can you not—foretell with certainty that there *will be* a crash within four seconds?

Whenever you know the two factors—the *nature* of conditions producing the change, and the *time rate* of the change—you CAN with certainty prophesy what will happen—not only four seconds ahead, but forty years hence! Yes, forty years hence! You see a mother today, loving her new-born baby boy. You know the *nature* of mother love, and the *time rate* of the endurance of that mother love—that is, its lifelong lasting quality! Hence you can prophesy that, that mother *will* love her boy forty years hence, no matter what kind of man he may be at that time.

In objection to this conclusion, one university logician once said to me, "But such prophecy is unreliable, because some exceptionally peculiar condition might *later* change that mother's love and make her hate her own son." To this I replied, "That also applies to all your arguments for sound reasoning, for whenever any peculiarly exceptional condition later changes any of the factors in your reasoning process, your original conclusion also becomes unreliable." *Whenever a soul knows the nature of changing conditions and the time rate of the change, prophecy can be as reliable as reasoning!*

Moreover, true prophetic vision leads man to the future, and man needs guidance for the future, *not* for the past. The wisdom of reasoning has been a ghastly failure as a guide. Men have reasoned about supply and demand, and millions have lived for

years in dire want in the midst of plenty. Men have reasoned about protecting the economic welfare of their respective nations, and have initiated wars which destroy economic values. Since the wisdom of man, based on reasoning, has failed us as a guide, it is wise to seek prophetic guidance!

1
2
3
4
5
6
7
8
9
10
11
12
13
14
15
16
17
18
19
20
21
22
23
24
25
26
27
28
29
30
31
32
33
34
35
36
37
38
39
40
41
42
43
44
45
46
47
48
49
50

XIII

WISE MEN AND THE INVISIBLE

As you know what will happen, when two automobiles rush at high speed toward each other in a narrow alley, so mystic wise men know what will happen in human progress. They know the nature of man's changing progress on earth, and the *time-rate* at which such changes are taking place and will take place. Hence they can with certainty vision the future for us!

I am writing of mystics! I am NOT writing of *mystifiers*, or charlatans. A mystic is one who possesses knowledge not yet known to the average man. There are many such mystics—chemists, astronomers, physicists and spiritual seers—and one group is as prophetic as the others! There are seers in each age. They guide each great advance man makes. *They are mystics because they possess knowledge not commonly known.*

In the far past, without help of our astronomical instruments, they determined with exactness, inclination of sun's rays at any spot on earth at any moment of any day of any year. They knew the three kinds of years, and constructed temples to represent those exact differences. They evolved means of determining length of side of a square equal in area to the area of a circle. They discovered the use of 3.1416 in mathematics—the greatest miracle of all ages. They discovered that on May 16 and July 26, the line to the sun 92 million miles away, coincides with the line to a star 335,000,000,000 miles away. See Appendix ONE, *Antiquity and Culture of Tiahuanacans and Mayas.*

Mystics are not fantastic. They do not travel about in purple capes. They are real; they live among us here and now. Their knowledge came and comes from the cosmic consciousness of the universe, to which mystics respond as fully as plants respond to sunshine. *Mystics do see the invisible!*

“The soul— like spirit—knows no space!
’Tis ever here and also there!
’Tis like the mystic light of suns—
A billion miles away, and also here.”¹

¹ *My Joy in Passing On*, by Brown Landone, p. 12.

PROOF OF SEEING THE INVISIBLE

This extraordinary power of mystics seeing the invisible is not mysterious. Our science has made 'little boxes' which work miracles just as mysterious. *For these little boxes do the same thing.* We call them special cameras—X-ray or infra-red ray or ultra-violet ray cameras. One kind can look into the body and see the penny a baby has swallowed. Another can see an invisible black hat on a black box in inky darkness! Another can look deep into solid steel. Seeing the invisible is no longer mysterious. With cameras, it depends on the vibrations to which the film is responsive. With mystics, it depends on the spiritual vibrations to which the soul of the mystic is *responsive*.²

YOU HAVE SEEN 1000 MILES

Because of his spiritual responsiveness, the mystic can see the invisible and hear the inaudible. His conscious mind transcends distance and space and time. You also have sometimes done the same thing. When dreaming, you have seen and heard people a thousand miles away. If you call this 'just imagination,' that proves my statement, for imagination is the power of the soul which transcends limitations of space and time!

Mystics do not live spiritually isolated. They are bound together in such perfect unity of love that their activities are silently harmonious and eternal. For thousands of years mystics have been united in great orders; each circling in a path of its own work; each in harmony with all the others.

"God made all things and souls
To fit within one plan, divine!
He made His stars to move
In constellations unified;
And hence, they never separate
To roam in endless space, alone!"³

Likewise, God's constellations
Of the mystic souls of earth
Are bound in unity
So that they too shall live
And love and work in unison
Throughout eternity!

² *Spiritual Responsiveness of the Body*, by Brown Landone.

³ *My Joy in Passing On*, by Brown Landone, p. 13.

Each circle has a head, supreme. Then one, above all other heads, who is the King of Power and King of Peace on earth, to whom is given power to ordain mystic priests of Most High God, whose revelations are now TIMED to man's increased capacity to understand and reach the goal. Today the revelation is: *This is the time of great transforming change! A time when prayer conceives, and action sires, a new age to be born within the hour!*

XIV

PROPHECIES OF THE MYSTERIOUS TELEOIS

I have already told you a little of what the mystics knew thousands of years ago, and of their recorded knowledge of movements of earth and solar system; proportional areas of circles and squares; discovery of the mysterious 3.14159 in mathematics; et cetera. *But what else did they know?* Let us consider something which everybody knows—like our own units of measure. All of our systems are very haphazard—seventeen kinds of bushels, two kinds of tons, three kinds of miles, for example.

In contrast, 9318 years ago—ages before the Egyptians existed—mystic masters of Tiajura conceived and recorded a measure of land¹ based on the movement of our earth. It takes our earth 365.2422 days to circle around the sun. So the mystics used this 365.2422 as the circumference of a circle. Then they determined the surface area of a circle bounded by such a circumference. Next they worked out with mathematical exactness a square of the same area as that circle. This square became their unit of land measure. All other measures—weights, quantities, time—were based on parts or multiples of the side of this square. *Thus, these mystic wise men determined a system of perfect units of measurements, as eternal as the stars!* Later, these were built into the key temples of the six civilizations now past; and today they are building them into the new Temple of our seventh civilization.

By use of such means, the mystics definitely recorded dates of great events prophesied for the future. To this day, their prophecies, revealed by the mysterious Teleois, *have come true!*

THEIR FORECASTS CAME TRUE

In 1936, the Teleois circles in the Temple of Initiation of the Great Pyramid were decoded for the years 1937, 1938 and 1939. The following dates were revealed: In 1937—January 30, July 30

¹ This was later built into the Great Pyramid in Egypt, and in the plan of Circles of Stone at Stonehenge, in what is now Wiltshire in England.

and November 5-6 of 1937. In 1938—March 11, September 9, 15, 21 and 29, October 1 and 7, November 10-11 and December 25 of 1938. In 1939—March 6, 15 and 29, April 9, August 9, 20-21, 30 and 31, September 1, 3, 20 and 27, October 5, 6, 14-16; November 4-5, 13, 27, 30 and December 5 of 1939.

What happened on the prophesied dates of the latter part of 1939 has already been presented. They did come true. And the prophecies of *the others have also come true.*

On January 30, 1937, Hitler voided Versailles Treaty. This upset world conditions because it unbalanced political conditions in Europe. July 29-30, 1937—Japanese conquered Tientsin in twenty-four hours—initiating a new era in warfare! It was the first proof of the effectiveness of bombing planes—conquering and burning half a city of a million people in one day! November 5-6, 1937—Germany, Italy and Japan united in anti-communism pact, the second step toward the establishment of a seven-power dictatorship of all the world.

FORETOLD FOR 1938

March 11, 1938—Hitler took Austria—a new era of expansion by force of fear. September 9, 1938—Hitler publicly notified Europe that Germany would never again “capitulate to any one.” September 15, 1938—Chamberlain went to Berchtesgaden to *ask* Hitler for peace in the Sudeten—amazingly significant as being first time in two centuries that a Prime Minister of the British Empire went to the head of another power to ask for anything. September 21, 1938—Britain and France secretly agreed to abandon Czechoslovakia. September 29, 1938—Four-Power meeting in Munich—proof of a new world condition, in which ‘sacred promises’ of great democracies are forgotten as easily as those of autocracies. October 1, 1938—Germans take Sudetenland.

October 7, 1938—surprising *evidence of inevitability of world war*, by revelation ² of British Cabinet’s disapproval of peace, and its intent to war—eight days after Munich peace agreement! Although to the English *people* Chamberlain had announced

² When Chamberlain, in speech to House of Commons, October 7, 1938, mentioned that there might still be hope for peace, there was DEAD SILENCE and NO CHEERS from the Ministerial Bench (Cabinet); when he asked Parliament NOT to take seriously his statement of peace made to the *people*, and also pled for support for his preparation for war, there was prolonged MINISTERIAL CHEERING. Please note, this was not the cheering of Parliament, but of Cabinet members.

"there will be peace in our time," on October 7 he explained in the House of Commons that they should not take that statement seriously. November 10-11, 1938—night of terror and horror for Jews in Germany—more than race persecution; this was the first revival in centuries of punishment of a race for the crime of *one* individual! December 25, 1938—the first Holy Conclave in the high Andes to sanctify the triple cross altar of the New Temple now being built, held by Thibetan mystics who had left Lhassa in 1922.

FORECAST IN 1936 FOR 1939

On March 6, 1939—Great Britain secretly decided to seek union with Communist Russia. On March 15, 1939—Germany took Czech provinces. On March 29, 1939—Madrid surrendered and Fascist dictatorship established in Spain. April 9, 1939—Italy seized Albania. *These dates, decoded in 1936, were dates of events of world importance which DID come true in 1939 as PROPHECIED!*

What took place August 9, 1939, fulfilling the prophecy of 1936, has already been told. What took place during the months immediately following is recent and remembered.

September 1, 1939—Germans into Poland; September 3—Great Britain and France at war with Germany; September 20—Russia and Germany agreed on Poland's partition; September 27—at Moscow, envoys of seven nations held conferences; Germany and Russia agreed on European spheres of control; in Poland, Warsaw surrendered.

October 5—Hitler decision affecting Italy in Africa; October 6—Hitler announcement of no peace, except Germany is dominant European power; October 14-15—sinking of *Royal Oak* (not important in itself, but because such a feat may be prophecy of the end of 300 years' dominance of the seas by battleships.)

November 4-5, 1939—fateful days³ for Europe as related to four dictatorships—Mussolini's shake-up of leaders; Germany's announcement of unrestricted sea war; Finland's refusal to cede

³ At the same moment, dates of days differ at different places on earth. For example, when in New York City it was 10 P.M. of *December 31, 1939*, it was 5 A.M. *January 1, 1940*, in Gizeh and Cairo. So also, when in 1939 it was 6 P.M., November *fourth* in New York City, it was 1 A.M., November *fifth* in Moscow and 8 A.M. of the *fifth* in Tokio. Prophesied dates accord with the wise men's use of Gizeh as base meridian.

islands to Russia; Russia's Communistic appeal to workers of Great Britain and France; Viceroy of India's announcement that promise of freedom for India would *not* be made; President Roosevelt's proclamation made the Arms Embargo Act effective; Leopold of Belgium and Wilhelmina of Holland decide on peace plan plea, followed next midnight by visit of Leopold to Wilhelmina, and publication of plea on the 7th; planting of time bomb in Munich on the 5th, with intention to assassinate Hitler three days later. A day almost as fateful as August 9th—seven intersections of Teleois circles in Pyramid. November 13, 1939—Japanese Ambassador reached secret agreement with Russia; Japan announced decision to lessen Great Britain's power in Asia; Finnish delegation breaks off conversations with Russia; Indian Congress demands independence from Great Britain. November 27, 1939—Finland refused to accede to Russian demands; Stalin made decision for immediate war against Finland; November 30, 1939—Russia launched movement against Finland, the Russian air fleet bombing Helsinki.

December 5, 1939—*the one most important and significant announcement of the year*—Japanese Ambassador in Rome publicly announces that four great totalitarian powers—Germany, Russia, Japan and Italy—**MUST ULTIMATELY UNITE!**

These dates were determined in 1936. Other dates—also determined by the three dimensions of the cubic space of the Pyramid and the Teleois—are determined for the next 13 years. Man is to enter the Temple of Transfiguration on March 7 of 1947; he will reach the Altar Ark by 1997.⁴

⁴ Mistakenly typed as 1947 in a sheet issued in early 1939. The year 1997 is the year revealed.

STRANGE PHRASES AND NUMBERS

In Thibetan translations of treasured scraps of manuscripts of designs of the Great Pyramid—in Sacred Library in Lhasa, and also in the Thibetan Monastery at Drepung—we find numbers designated by names and phrases. These seem strange to us, but no stranger than our symbols will some day seem to others—France a *rooster*; our Progressive Party a *bull moose*. Anyway, it is necessary to understand the ancient signs to be able to interpret the prophecies.

There is a reason for the use of such symbols. The mystics were recording prophecies for tens of centuries! And for this purpose words and even figures are not safe; their meanings may change. For example, only 120 years ago, the word *woman* had a bad meaning; but it was polite and dignified for a man to call his wife his *female*. And similar figures do not represent similar numbers to different peoples. Our 265 means 265 to us. But in one of the most marvelous numerical¹ systems of all ages, that same 265 means 925! See Appendix ONE, *Antiquity and Culture of Tiahuanacans and Mayas*. So the mystics used terms based on numbers, fixed for eternity—days, seasons, moons, et cetera.

For example, the phrase *circle of days* always means number of days necessary for earth to circle around the sun—365.2422 days.

So also, *seasons* means *four*.

Days of creation means *seven*.

Moons of the circle of days always means 13—because the moon circles the earth 13 times during each year.

Cycle means 100. *Fingers* means 10.

SPACE means the *square* of a number—for the ancients thought of space as an area. Hence, the *space of the seasons* means the square of 4—that is, 4×4 or 16. The *space of the moons* is 169—that is, 13×13 . And SOLIDITY means the *cube* of a number. Hence, the *solidity of the moons of the circle of days* is $13 \times 13 \times 13$ or 2197—that is, the cube of 13.

¹ *Old Civilizations of the New World*, by A. Hyatt Verrill, pp. 110-111.

Resolved unto perfection is a phrase used by all ancients, and particularly by Pythagoras. The ancients *resolved* numbers, not to get arithmetical results, but to convey meanings. See Appendix SEVEN—*Determination of Dates of the Hall of Unity*. A number is resolved by the addition of its digits. That is, 13 is resolved by adding its '1' and its '3'. This makes 4. Hence, to the ancients 4 was the perfect resolution of 13. But the ancients did NOT mean that 13 is the same as 4. But they used 13 and also 31 with *meanings* associated with 4.

QUEER DIRECTIONS

In the Thibetan manuscript scraps, containing directions for the building of the Great Pyramid, we find this: "Thou shalt build the Temple of Mystics, at the core of the pira-midos . . . as of the *spheres of creation*; and from the perfection of 'one', unto the *third perfection, resolving unto the seasons of the sun*." Of course building the Temple of the Mystics at the core or center or axis of the Pyramid is understandable. But what does the rest mean?

(1) To build it as of the spheres of creation, means to build it on the basis of 7 spheres.

(2) To build it *from* the perfection of one, means that the diameter of the smallest sphere shall be *one unit* of the proportions used.

(3) Unto the "*third perfection which resolves unto the seasons of the sun*" means that the diameter of the largest sphere shall be 31 units.

But how does one get 31 out of that phrase? *Seasons of the sun* means 4. The *third perfection* resolving unto 4 is the third Teleois number whose digits—when added—will make 4. 13 is the first number whose added digits equal 4; 22 is the second; 31 is the third. From 1 to 31, NO other number resolves into 4. 31 is the *third perfection* resolving unto 4. Hence, to be built of *seven* spheres, and to be Teleois, and to start with *one* and end with 31, the diameter of the spheres must be 1, 4, 7, 10, 13, 19 and 31. See *Figure 7*.

Such spheres, represented by circles in diagram, determine to 1/10,000 of an inch the size of the inner Temple of the Mystics and the total time revealed by the entire Pyramid! Figure 7 reveals a miracle of perfected construction. The circle of 31 unit diameter contacts floor and side walls; and within the circle of

31, six other Teleois circles contact and intersect in perfect proportions. Above the 31, circles of 4 and 1 reach to bar marked on west wall in the gable. In architectural construction, this is something beyond any ideal of perfected structuring employed by architects today.

MEANS OF DETERMINING DATES

Mystics used the seven spheres as symbols in several ways—the seven days and powers of creation, seven bodies of men, seven ages on earth, seven steps of progress, et cetera. But to us at this time, their importance is their exact determination of time periods and dates in the Pyramid.

A few readers, more mathematically minded than most, may wish to know more of how time periods and dates in the Pyramid are determined. This is NOT of particular interest to the general reader, and the processes are tedious and mathematically complex, so I give only a suggestion of them in Appendix SEVEN—*Determination of Dates of the Hall of Unity*.

If symbols of the wise men seem strange to us, imagine what an archeologist 6000 years hence may think of us, when he unearths records which show that we fought wars under symbols of *star and crescent*, *hammer and sickle*, and *swastika*; and elected men to the highest office of the greatest nation of the world under the symbol of a *donkey* or an *elephant*! Study the strange phrases of the wise men, as a step in *expanding your mind* out beyond your present ideas; it will tend to make you more responsive to the knowledge of the mystics and to feel more in unity with them.

XVI

DEEPER MEANING OF THE TEMPLES

Man has been developing for long long ages. Four sciences prove it—archeology, geology, paleontology, and anthropology. The Neanderthal, Heidelberg, Piltdown, and Trinil Java man, existed from 300,000 to 900,000 years ago. And scientists now say, 2,000,000 years ago for earlier man. The ages of these men are represented by the Pyramid's Descending and Ascending Passages; they are of no practical value to you, and not discussed here. Cro-Magnon man of 25,000 years ago, nears the genesis of early civilizations.

Neolithic culture in Europe existed 12,000 years ago; in Asia, 20,000 years ago; and in the eastern Andes several thousand years *earlier!* One of the most awakening facts is that man had well developed ideals of an immortal life and a hereafter, 30,000 years before the early Neolithic cultures mentioned above—some 50,000 years ago!

Scientists are now certain that man was making polished stone¹ arrow heads, 1,000,000 years ago; and even in North America, stone heads² and faces were carved 25,000 years ago!

Civilizations are older than historians once thought. Once archeologists believed that the oldest developed civilizations were only 4000 years old. Now we know that Ereck was noted as the "*City of Books*", 6000 years ago, and thousands of years of culture must have preceded an age of preservation of books in hundreds of libraries. Then 10,000 years ago, the peoples of those regions had "invented the keyed arch"³ and they used tile for excellent systems of sewerage". Other civilizations, older, built homes in which they used *rugs* on the floors—8950 years *before* the time of Queen Elizabeth of England, when floors of many English castles were still hard packed *dirt* covered with straw.

Other excavations on the Indus reveal a city laid out by a *City Planning Committee*, 7500 years ago. Ur was a developed

¹ *The Advance of Science*, by Watson Davis, p. 341.

² Report of Dr. E. H. Sellards, University of Texas.

³ *The New Science and the Old Religions*, by Thornwall Jacobs, p. 366.

city 6500 B.C.—that is, 8450 years ago; Susa, 9950 years⁴ ago; Nippur, approximately 11,900 years ago; and well advanced Caucasoid culture of Anau⁵ was still earlier—setting back still further dates of Pumpelly which were once considered exaggerated. The evidence of the great age of man of ideals, is certain: Nothing but an ideal of immortality, could have inspired the “hope which was in the heart of the Neanderthal parents who buried their boy with his head upon his arm and placed by his side his best loved implements and his most precious treasures 50,000 years ago.”⁶

In the eastern Andes and perhaps in Asia, man began organized co-operation with other men 23,000 years ago. In the Central and South Americas, there are ruins of undated civilizations—an amphitheatre⁷ seating 10,000 people; a plaza⁸ of 1,000 statues, a palace of 3,000 stairways.⁹ Then thousands of years later, all the waves of civilizations were represented in the Pyramid, by the Great Hall of Progress. *This Hall is the largest and in many ways the most significant chamber of the Pyramid.* Its size symbolizes ages of time! Yet, usually writers and lecturers are blind to its importance, cut its time to a few years, and give little or no attention to it. Here, in the next Chapter, its great significance is recognized.

⁴ *Ibid.*, p. 355.

⁵ *The Early Empires of Asia*, by William Montgomery McGovern, pp. 3, 27.

⁶ *The New Science and the Old Religions*, by Thornwall Jacobs, p. 370.

⁷ *Mystery Cities*, by Thomas Gann, p. 216, 218.

⁸ *Old Civilizations of the New World*, by A. Hyatt Verrill, pp. 76-82.

⁹ *Ancient Andean Life*, by Edgar Lee Hewett, p. 254.

XVII

MEANING—HALL OF PROGRESS

21,785 B.C. to 1847 A.D.

This first date of 21,785 B.C. in this Hall is definitely designated in the Pyramid. This date approximates the dates of man's early cultures as now determined by archeologists. A few years ago they thought I was mistaken in insisting that man's cultures went back 23,900 years. Today, excavations have given proof, now accepted by four sciences, of carved stone faces more than 25,000 years old.

So also great age of the early civilizations of the *eastern* Andes is still today the most stupidly unrecognized fact of history. Later archeologists are, however, recognizing that the civilizations of high Peru were "hoary¹ with age" when Egypt was an infant.

We go back many ages to the time symbolized in this great Hall of Progress which portrays the great *expansion* of man's civilizing activity on earth. It also represents the worship and use of the power which was first used by God in creating the heavens and the earth—symbolized in our Bible by the power of the first day of creation. *Ouranos*, a word of Koine Greek in the New Testament, is translated 'heaven'; it is the word Christ always used for heaven. The word means *the infinitely expanding² activity!* And this Great Hall of Progress is the symbol of *this same expanding power of the soul of man*. Of the seven dominantly spiritual powers³ of the soul, this expanding power is the power which must be idealized and first used, if man is to realize what his soul desires today.⁴

AMAZING TIAHUANACANS

This was the power most worshipped in the civilizations of the Tiajurans and pre-Tiahuanacans. It probably explains why,

¹ *Ancient Andean Life*, by Edgar Lee Hewett, p. 263.

² See marginal note of meaning of the word "heavens" in Revised Version of the Bible, first chapter of Genesis.

³ *Spiritual Responsiveness of the Body*, by Brown Landone, L-I, p. 4.

⁴ *What to Do in These Years—Four-Fold Plan of Action*, by Brown Landone, L-I.

in nineteen different ways, their civilizations surpassed anything ever attained by any and all succeeding civilizations. Elsewhere I tell you of some of their attainments in surgery and dentistry, of their marvelous system of land culture,⁵ social justice, use of gigantic stones⁶ in building, an amazing wall so great and long, it makes the Great Wall of China look like a wall of a child's building blocks; most marvelous stone-cutting ever done; largest single stone statue ever carved; first great stone wheel; plating of metals; finest woven textiles—300 threads⁷ to the inch; most permanent colors; sliding scale rule; and gold, gold, gold—furniture of solid gold; great temples, walls lined with gold inside and out; millions of caskets, gold lined! And remember, *time for leisure and enjoyment of life was compulsory by law!* See Appendix ONE—*Antiquity and Culture of Tiahuanacans and Mayas.*

They worshipped the ideal of radiance in expansion, as the supreme power of God. This seems to have dominated their entire civilization. Perhaps we may find that their consecrated worship and use of this power *expanded the human races and spread them out into the multiple types we find everywhere on earth!*

ALL FACES ON EARTH

I give much earlier dates to Andean civilizations than historians do. There is not even one recorded date. All opinions of the historical authorities are *opinions!* But the archeological evidence of great age is conclusive. When evidence differs from opinion, I accept the evidence. Opinions of authorities often become *fixed!* 2280 years ago, the highest authorities in physics formed an opinion that the atom was solid. It became a fixed idea, and twisted all scientific work of authorities for 2243 years! So also, 200 years ago—before we had any facts—someone advanced an opinion that all early people in America came from Asia. Hence everybody accepted the idea, that they could not be as old as the Asiatics. That opinion became 'fixed' and has *twisted* every examination of evidence for 200 years. It is mistaken.

⁵ *Ancient Civilizations of the Andes*, by Philip Ainsworth Means, pp. 287-291.

⁶ *Ancient Andean Life*, by Edgar Lee Hewett, p. 260.

⁷ *Old Civilizations of the New World*, by A. Hyatt Verrill, p. 322.

The early Andean people did not come from Asia. Before me now, I have several scores of photographs of pictured faces. The original of every one of these was painted or sculptured by pre-Tiahuanacans⁸ or later Andean civilizations. *These portraits exactly portray ALL types of people of all races of the world!* Scientists cannot find on earth today any face which was not portrayed by the Andeans, *thousands of years before the type existed elsewhere on earth!* The evidence is overwhelming. Races evolved here in the Andes, and then *expanded* out over the rest of the world; otherwise portraits of ALL faces of ALL races would not be found in the Andes.

Among the faces portrayed by the early Tiahuanacans there are Chinese faces, Egyptian faces, faces of sour New England bankers, Burma faces, highly intellectual faces, Jewish noses, pompous faces of fat bishops, lean faces of Yankee horse traders, Hindu faces, faces of savage Australian bushmen, of ascetic priests, peasant faces—English, French, German, Italian, Russian, Irish—and these were sculptured and painted thousands of years before there were any English or French or German or Irish people in Europe!

Every type of face found on earth today was portrayed thousands of years ago by the peoples of the civilizations who worshipped God as the *expanding* spiritual power of the universe.

I give more time to this civilization than to any other, because I wish you to recognize its *value to you!* Picture the structure of this Hall, the *upward incline* of the floor, the great uplift at the end of these ages of man's progress, with vision of great expansion of space, with 31 symbols of *infinitely expanding activity!*

This is what this Hall means to you: it is the first Hall; it is the *first step* in every advance of man; all man's material success and attainment are due to *expansion* of his ideas, desires and activities. *And the highest in spiritual attainment comes only by such expansion of consciousness, that man reaches unto God.* All you desire to attain will be won only as you start with this first power, and *expand* from what you are, into that which you desire to be!

⁸ The term pre-Tiahuanacans is here used in a general sense, to designate all *eastern* Andean peoples developing prior to the Tiahuanacan cultures.

XVIII

MEANING—THE GREAT UPLIFT

March 6, 1847—January 2, 1883

Before man leaves the Great Hall of Progress, he comes to *The Great Uplift*. It symbolizes the first Melchi-Zedek *Uplift* in each individual life, as well as in each civilization. During this time—March 6 of 1847 to January 2 of 1883—man felt the wrongs done to races, and desired to remedy them. Hence the Great Uplift was a time of *lifting man up out of bondage*. Our Civil War freed four million slaves; Russian serfs were freed by proclamation; and Japan abolished feudalism in 1871. *More movements for freedom from bondage than any other period three times as long!*

Also, new movements for the uplift of man's *mind*—for first time in history, widespread free public education and public libraries; even in Japan—emerging from isolation—free public libraries were established. And movements for *political* freedom swept the world.¹ A new movement for freedom in Germany led to a new constitution for the German people; Cavour and Garibaldi in Italy; in France, Louis Philippe abdicated and new republic was established; in Greece, a constitution for the people was put into force; in Holland a constitution was granted to the people. In the same period, Canada gained independence as a Dominion; Mexico abolished foreign rule and became independent; Bolivia adopted a representative constitution; and in far Asia—in Japan a constitution was decreed; in China, Tienteh was trying to establish Christian *brotherhood!*

UPLIFT FOR THE INDIVIDUAL

The Great Uplift—freedom, freedom, freedom! *Its prophecies are fulfilled!* Our prayerful thanks are due to those ancient mystic men of the Order of Melchi-Zedek, who built this great uplifting step as a symbol of real meaning for us as individuals!

¹ *History of Civilization*, by Brown Landone, Vol. VI, Age of Attainment, pp. 14-20.

Even its placement is significant. It is between *expansion* and *idealization*! First, in the Hall of Progress, expansion of your efforts; now second, the uplift of freedom; and next, you will come to the Platform of Idealization—to turn all your effort—of expansion and freedom—to *an ideal of what you want to attain!*

The Pyramid prophecy of the Great Uplift of freedom did come true! *Search all the documents of history, and it is impossible to find any other prophecy of 4821 years ago so truly and completely fulfilled!* What these wise men embodied in the structures they built, is the clearest, surest, sanest and most definite guidance man can find today. *Such is the guidance given to us by men of an order extending far back into the past, and looking to the future.*

At the top of the Great Uplift, you find the Grand Altar-Platform of Aetheric Consciousness—one of the most significant structures of the Pyramid. Yet all recent writers overlook its significance. Let us now move on to this magnificent Altar-Platform.

XIX

MEANING—ALTAR-PLATFORM

January 3, 1883—June 27, 1914

The name, the Altar-Platform of Aetheric Consciousness, IS appropriate. Imagine man—for tens of centuries—believing that he was living inside a great cube of thick sticky solid clay, in dense darkness! Then, in a split second, man discovers that the clay has disappeared, and he is living in a beautiful, pulsating glory of rainbows of light! Yes, *in it!*

Words cannot overstate it. For 2243 years, man had accepted the mistaken idea that the atom-unit of matter was SOLID. Then—on this Platform, in but 31 years—that concept vanished, and man was given the revelation that the so-called matter of the atom was naught but a *miniature universe of torrential whirling energy—universal spirit!*

This Altar-Platform symbolizes the particular years during which man first attained Aetheric Consciousness, received revelation that all matter *is* etheric spirit, and—illuminated by this new consciousness—began to *idealize* the structure of all things and of the universe. So also, when YOU arrive at this same point in your individual development, you can look back over all your past material progress, and realize that all of it is but the prophecy of greater things you can attain by recognizing spirit in all things, and *idealizing* it.

Man's experience on this Platform transformed the universe for him, between January 3 of 1883 and June 27 of 1914. And this had been prophesied 4821 years ago! It seems almost impossible that so much mysterious new knowledge could have been revealed to man in so short a time: Hertzian waves discovered in 1887; the Spectro-Heliograph came in 1891; X-rays discovered by Roentgen in 1895; Radio-activity discovered by Becquerel in 1896—first knowledge that there are rays which penetrate all substances; discovery in 1897 that the atom is not solid; that it possesses negative and positive particles of electric energy—first new knowledge of atom in 2243 years.

This was the first marked advance in recognition of the etheric

nature of all matter. It was the first new idea of the nature of the atom, since 300 years before Christ taught by the shores of Galilee. Then within another year, after discovery of real nature of the atom, came the Curie discovery of radium in 1898; then use of wireless in 1899; Quantum Theory by Planck in 1900, and Geitel's recognition of cosmic rays! Then each year of the next twelve years, new discoveries were made, augmenting the knowledge of cosmic rays.

TITANIC SPIRIT IN BODY

During this time, man also recognized that the cells of his own body were composed of energy, whirling vortices of titanic spirit, instead of solid units of lifeless matter.

EFFECT ON MIND AND THINGS

Discovery of the etheric nature of matter *expanded* man's attitude of mind far out beyond all ideas of what he previously considered possible! The impossible began to seem possible, and this new attitude led to man's transformation of things!

So, on this Altar-Platform, in little more than 31 years—from 1883 to 1914—*man's creation and use of new things and processes expanded with almost explosive speed.*

ALL IN 31 YEARS

It had been prophesied, and it came true! This period was the miracle age of expansion of man's ideas into inventions and new processes. A partial list includes: 1883—First Rayon by Swan; 1884—Manganese Steel; 1884—Fountain Pen; 1884—Trolley Car; 1884—Steam Turbine in England; 1885—Alternating Current Transformer; 1885—Linotype; 1886—Smokeless Powder; 1887—Rotary Converter; 1887—Monotype Setting; 1888—Two Tube Pneumatic Tire; 1888—Adding Machine; 1888—Daimler Automobile; 1888—Transparent Photo Film; 1888—Induction Meter; 1892—Alternate Current Motor; 1893—Motion Picture Machine; 1894—Submarine; 1894—Dry Air Blast Furnace; 1895—Moving Picture Projector; 1895—Low Frequency Wireless; 1896—Modern Disk Plow; 1900—Steel Electric; 1900—Diesel Motor; 1901—High Speed Alloy Steel; 1902—Photo by Wire in Germany; 1902—Radio Sending Apparatus; 1902—Radio Telephone; 1903

—Airplane; 1905—Presentation of Einstein Theory; 1907—Vacuum Tube Radio; 1909—Bakelite Synthetic Resins; 1911—Hydro-aeroplane; 1913—Nitrogen Fixation.

The earliest invention we call a great invention was first known long ago. There have been less than 150 important inventions in the last 3180 years! And less than 60 of these are called great inventions. Now what happened on the Altar-Platform from 1883 to 1914? *More than half of the great inventions of 3180 years were first discovered or perfected in these 31 years!* If any one had in 1880 prophesied that even half of these would come true in 31 years, he would have been considered insane. Yet 4821 years ago, wise men knew these things would be created. What the Altar-Platform meant to man, it can mean to you! All is energy; *idealize* all things as of spirit; and *create* new work and new conditions for yourself!

All things are of spirit, even our "ideals are the *substance*¹ of things that are . . . if you could but know that matter is not so dense as it seems, not so solid as it appears, not so lifeless as it is assumed to be . . . that matter is only energy in reality,"—then direct creation of things by spirit would approach perfection on earth.

¹ *Desires and Ideals*, by Brown Landone, pp. 13-14.

XX

MEANING—HALL OF UNITY

June 28, 1914—January 12, 1919

Although motives of individual nations differed in this Hall, yet it does symbolize the *first great movement of man on earth to attain a common goal, by unity of organized action!*

Those of you who have read the Pyramid prophecies of Davidson and his followers know that the time period and dates he designates are almost correct for events of the First World War. See Chapter VIII and Appendix FOUR—*Davidson's Dates*.

We marvel at lecturers and writers who tell us that, because of their faith in the prophecies of Davidson's book, *The Great Pyramid and Its Divine Message*, they anxiously waited in early November 1918 to see if the prophesied date of November 11 would be the end of the war. We marvel in particular at one widely known lecturer, who in hushed tones tells his audiences how he awoke that November 11 at four in the morning and, with Davidson's book before him, waited moment by moment near his radio, for news which would prove that Davidson's prophecy had come true!

We marvel, because the first little 'one-sentence' broadcast of news was not made until two years later, and there was no general broadcast of news until early 1922. Then also, we marvel that these writers and lecturers could study Davidson's book in 1918 because it was not even written, according to Davidson¹ himself, until five years *after* the war ended, and was not published until 1924.

The true and more exact dates of this Hall are indicated by the intersections of circles and the boundaries and centers of squares which represent spheres and cubes, in *Figure 9*. Some of these dates are outstanding because of double emphasis, such as: June 28 and August 7 of 1914; April 30 and May 7 of 1915; February 1 and October 27 and November 7 of 1917; September

¹ *The Great Pyramid and Its Divine Message*, by D. Davidson, Preface to Sixth Edition, p. vii.

22 and November 9 of 1918; and the last day in this Hall of Unity, January 12 of 1919.

NEW WORLD ERA—BROKEN PROMISES

It seems that the mystics were not concerned with mere official verbal acts—such as the date when any nation declared war, and that they thought more of dates of *events which initiated conditions which led to great changes for all the world*. The first date of this Hall, June 28, 1914, represents more than the personal assassination of Archduke Ferdinand of Austria; in reality, it led up to *changes which rocked the world*. So also, Germany's invasion of Belgium, August 7 of 1914, was of world importance. It was the initial step in the breakdown of 100 years of international faith in the pledged word of nations. That act initiated a new era. *Since that day, NO great nation has lived up to the ideal of keeping its promises!*

The record of the democracies is not honorable: in 1918 Germany signed an armistice because of the sacred promises of President Wilson's Fourteen Points; but by the time the Peace Conference was ended, each promise made to Germany had been broken by all the allied nations. In 1919 great nations accepted mandates of great territories, promising not to annex them, but to guard them as a sacred honor; today such territories are "*possessions never to be surrendered.*" Also in 1919, all allied nations sacredly pledged themselves immediately to begin to disarm, and at once all began to increase armaments. Later, Great Britain promised 46 nations to enforce economic sanctions against Italy, because of its invasion of Ethiopia; then forgot the promise—soon after the Italians took Lake Tanya in Ethiopia. Lake Tanya is the headwaters of the Blue Nile. With explosives, Italian engineers could have diverted the waters of Lake Tanya, and made all British Sudan a desert.

The most sacred promise of ages was England's promise to Jewry—Balfour's statement of protection of a Jewish homeland in Palestine; yet even it was publicly and callously renounced. The Arabians who opposed the Palestine homeland are religiously at one with millions of subjects of British India. Britain and France also with high honor pledged themselves to go to war to maintain Czechoslovakia and Poland; we now know what they did not do. The breaking of promises spread to the United States. For generations it had promised its people to redeem its

bonds in gold; yet, when advantageous not to do so, the government forced itself by Federal law to break that promise.

Most certainly totalitarian powers broke their promises also: Germany broke its promise not to militarize the Rhineland, not to annex Austria, to respect the integrity of Czechoslovakia, not to take any more territory in Europe. Poland during its twenty years repeatedly broke its promises—seizing and grabbing territory from smaller or weakened nations, even against the decisions of the Council of Ambassadors and the League of Nations. Italy, Japan and Russia did not break definite promises to small nations, because they did not make them in the first place; but they made promises to the League of Nations and broke most of them. In the Far East, Chiang Kai Shek was elevated to power on his promise to fight to the death, the Chinese Communists; when advantageous to him, he made alliance with the Communists and made their army his chief support.

August 7 of 1914 was more than a World War date. It was prophesied 4821 years ago that it would be the beginning of the breakdown of the pledged honor of nations! That prophecy has been fulfilled!

OTHER DATES OF WORLD SIGNIFICANCE

May 7 of 1915—sinking of the *Lusitania*, and February 1, 1917—Germany's start of unrestricted submarine warfare—are of world significance, because they symbolize a new policy of modern war—war on women and children! October 27, 1917—first union in action of an American army with armies of Europe, Africa and Asia. November 11—the day of the signing of the Armistice—is not recorded. November 9, 1918—the German Kaiser's abdication and flight to Holland—to the ancient mystics that was of greater significance than the Armistice of November 11, 1918. See explanation, latter part of Appendix SEVEN—*Determination of Dates of the Hall of Unity*.

END OF GREAT UNITY

The time period of this Hall of Unity does not continue to the end of the Peace Conference, because its *unity in action ceased a little before midnight, January 12, 1919!* Clemenceau, Lloyd George, Orlando and Wilson met that night in secret conference. Wilson wanted a peace just to the Germans; Lloyd

George insisted that German leaders be punished and the Kaiser hanged; Orlando threatened to return to Rome unless Italy were given great sections of Austria and Germany; and Clemenceau *demande*d that a treaty be made which would make Germany an industrial and financial vassal of France for a century! *The period of unity of action ended that night*, and this fact had been apparently known, in some strange way, by the ancient mystics 4800 years before that event, for their prophecies end the time period of the Hall of Unity on that night, instead of carrying on the pretext of unity until the end of the Peace Conference, June 28, 1919.

FOR YOU, there is remarkable help in the meaning of this Hall. In the Hall of Progress, you learned that *expansion* of activity is the first step in attaining what you desire; at the Great Uplift, that giving *freedom* to your efforts comes next; on the Altar-Platform, that both things and activities must be *idealized* to attain the highest; and now in the Hall of Unity, that disunity brings conflict and failure, and that attainment comes by the unified use of mind, love, action—in fact, all of the seven powers of the soul!

XXI

THE VICIOUS WAR FOR GOLD

1921-1933

I write briefly here of this War for Gold, because it was carried on during time periods of three chambers of the Pyramid, and is not limited to the meaning of any one Hall or Temple.

January 28, 1920, *eleven men* covertly met for a week of secret conferences at Aix-les-Bains in Switzerland. Five were financiers; six, international munition dealers.¹ *They planned in detail, and later secretly carried on, the most vicious war of all ages!* It was waged under cover for thirteen years, 1921-1933. It was the *Second World War*.

The concept was titanic, the purpose diabolic: not only to incite more wars, but to gain ownership or control of the gold of the world. By this means, they planned to control the means of livelihood of 42 nations and one thousand million people of earth, and to reap profits from all their means of production and world trade. Since there were no armies in trenches, few people recognized it as war. Yet it was war, waged by Machiavelian leaders, who planned to gain their ends, by ruining nations and starving hundreds of millions of people into economic serfdom.

This War for Gold *was* a war! British and French diplomats knew that it was war, although some of them did not recognize that it was a war, alone by itself. Speaking of one of its events in 1931, a British² diplomat called it the beginning of the next war; a French diplomat called it a maneuver in the 17th year of the old war which had begun in 1914. But at any rate, *it was a war!*

The vicious leaders almost succeeded, and the results, in widespread devastation and ruination of individual lives, were ten times greater and more terrible than the results of the First

¹ These were dealers, not munition *makers*; there is no evidence that any American, North or South, ever knew even in later years of the meeting or the plan.

² Address by Frank H. Simonds before the Foreign Policy Association of New York City, November 21, 1931.

World War of 1914-1918. Nations were ruined financially, monies debased, industries and economies ruined, and peoples thrown out of work and impoverished.

How different it all might have been, if we had known at that time, of the prophecies foretelling that war, and had been guided to crush it before it got well started!

IT WAS PROPHESED

This war was definitely prophesied in the Pyramid, by the symbol for gold, being followed by a number sign of lustful clawing effort, from 1921 to July 1933.

This sign differs from the spiritual symbol of gold used in the temples of the Tiahuanacans, who idealized gold and linked it to the sign of God. To them, the golden light of the sun was the shining radiance of God, and gold was the one shining radiant yellow substance on earth; so they believed that some of the essence of God was embodied in it. But in three Pyramid chambers, this divine sign of gold is missing! Then on July 4, 1933, it reappears in the Temple of Initiation; where the symbol of gold is followed by three symbols—of service, brotherhood, and divinity!

The definitely fixed prophesied dates of this World War of Gold, are presented in Appendix EIGHT—*The Gold War*. Those who desire to know more of the leaders and sinister and silent operations of this most vicious of all wars, and of what defeated them, should read the Appendix.

Several authorities now realize that the results were more devastating, and caused more widespread human misery and tragedy—than any other war of the past. A report on conditions in Europe in 1931, by a conservative historian and editor, states: "The extent of the economic and social disaster . . . may not be ascertained in our generation . . . I do not know how I can convey⁸ . . . any impression . . . of the mingled terror and passion which fill the daily routine of millions of human beings."

Millions of this generation live hopeless lives because of the ruin of their businesses and the loss of savings during the third campaign of this war; and tens of millions of the next generation will suffer ill-health and nerve depletion because of the semi-starvation of body, due to the deprivations caused by the thirteen years of this most vicious war of all world wars.

⁸ Frank H. Simonds in Pamphlet 77 of the Foreign Policy Association, December 1931.

XXII

MEANING—TEMPLE OF REVELATION

January 13, 1919—October 21, 1929

This Temple is the smallest in length, and the most significant. As the Temple of *Revelation*—1919 to 1929—it is appropriately named, for its revelations, like spirit itself, seem to be limitless. Its miracle of exactness deserves a word here.

Its complex and mathematically exact calculations may be tedious, but they prove that the mystic wise men knew what they knew, recorded it, and revealed it for us with amazing exactness and certainty! In this Temple the unit of three systems of measurement is built into the stone structure, and to construct the cubic-space-time of the Temple, so that it would embody these units of measure, they added fractional parts of itself to itself in decimal parts of Teleois parts—using $1/10$ of $1/1000$ of $1/4$ of the basic sacred cubit, plus $1/10$ of $1/1000$ of $1/7$, plus $1/10$ of $1/10,000$ of $1/13$, et cetera. *And the ultimate total time space for the cubic space is exact to 67/1,000,000 parts of one second per day!* Such was the mathematical exactness of the mystic wise men who left direct guidance for us today!

STRANGE SYMBOLS

This Temple reveals the cause of the kaleidoscopic change which began taking place in government in 1920—the change from the world's 2400 years of evolving democracy, to widespread dictatorship in 17 years. It reveals this by four number signs—of *mass-man*, *goal*, *talk* and *action*. These show that as man was forced by machines to give up his habit of *productive* action, he substituted *talk* for action; and that, therefore, man is now uncertain of his own future and suffers a greater feeling of frustration and helplessness than ever before in history! See also Chapter XXIX. These signs also reveal that from this age on, talk and discussion will not solve our problems, and that man can no longer succeed by the means he has used in the past! A *new* mode of action is symbolized: Action of the machine is no longer

related to man's action. Instead, there is the action of man to man, in mutual service!

There are also symbols of '*exploding spirit*' and of '*man reaching toward limitless energy*.' These prophecies seem to have come true—and in the very years indicated—by man's discovery of means of breaking down the nuclei of the atom which points the way to release of titanic energy, and by man's new knowledge of cosmic rays—a source of almost inconceivable energy. Teleois symbols in one place, relate *man to wings and water and lightning speed*; and in another, to *sound and lightning speed*. These prophecies seem to be fulfilled by man's first airplane flights over oceans, and his use of radio to hear sound instantly from a thousand miles distant—both attained by man—as prophesied—during his years in this Temple.

TRANSFORMATION PROPHESED

Perhaps, for us personally, the most interesting prophetic revelation of this Temple is that *man is rapidly approaching an age of transforming change*, in which science will provide man with the means by which he CAN transform his own body—attaining augmented vitality and a new youthfulness dreamed of for ages; and that man can also—by idealized means—transform conditions around him!

Another prophecy is the revelation that, from the ninth year in this Temple—that is 1928—*all assumed values shall lose all bases of stability*; the signs of 'floating' values continue up to the last day in the Temple, and then end abruptly in zero, October 21, 1929. This prophecy seems to have been fulfilled by the panic and security market crashes of October 1929. *The revelation of revelations in this Temple is the prophecy that the holiest of holy men of Thibet will go back again to the eastern Andes which they had left many thousands of years ago.*

THEY HAVE COME TRUE

The signs of *man and wings and water and lightning speed*, determined by the masonry of the Great Pyramid, which was sealed¹ 4815 years ago, were related to the following dates: May 31, 1919; June 15, 1919; October 12, 1924; May 21, 1927; and September 4, 1929.

¹ The Pyramid was sealed 2875 B.C.

Those prophecies have come true: May 31, 1919—first seaplane to cross the Atlantic Ocean from America, reached England; June 15, 1919—first non-stop west to east airplane flight was made across the North Atlantic; October 12, 1924—first great airship left Germany for the United States; May 21, 1927—Lindbergh arrived in France, making the first non-stop flight across the Atlantic from the United States; and September 4, 1929—the first airship flight around the world ended.

EXPLODING SPIRIT

Then also, the prophecies of '*exploding spirit*' and of '*man reaching toward limitless energy*' have come true. During the years of this Temple, for the first time in history, energy was released from the atom artificially by man; soon afterwards, weights of isotopes were exactly measured; by 1922, the means by which matter can be artificially disintegrated were advanced and five elements had been partially disintegrated; knowledge of the new quantum mechanics of the atom was presented; and great advances made by Millikan and Compton in the study of cosmic rays; new practical means of using other rays were perfected; first photograph by wire was sent 1000 miles, from St. Louis to New York; and wireless—after waiting 20 years—spread as radio broadcasting throughout the United States in only 90 days!

ABANDONING THIBET

From the standpoint of the super-attainment of man, the great revelation was that the mystics intended once again *openly* to guide man to peace on earth! From the time the mystic wise men of old glorified the Holy Temple of Heaven in Cathay—2348 years before they went to Thibet—no word had been openly given the world of their deep concern in conditions affecting man's outer life on earth. But on January 13 of 1919, it was decreed that the Order Supreme should radiate spirit-in-action as well as spirit-in-conception—to help man to transform himself and his nations; and in 1921, word was sent forth! For 1100 years, the high mystics of the world had centered their work in Thibet. During the 19 years from 1903 to 1921, they weighed in the balance. First, the changes in the lower orders of priests² in their consecrated orders in Thibet—not only in the lives of

² The lessening of high spirituality was due in part to outside influence of the Europeans who had forced their way into Lhasa in 1867, and also to the persisting efforts of unfitted men to enter Thibet seeking initiation.

monks in the three great monasteries, but of priests in the Temples in Lhasa itself. Second, they weighed man's great world struggle for power and world dominance on the one hand, and for freedom on the other—unsettling the previous vibratory stability of all Asia.

THIBET TO THE ANDES

So on February 22, 1922, the last great conclave of the holiest of the holy was held in the Temple of Temples in Lhasa. On March 6, the Thirteenth Dalai Lama left Thibet; a subordinate took his place and name, so that the remaining lower orders of priests did not even know the great holy man had gone. These two dates are indicated in the Pyramid by circles determined by the cubic space of the Temple, finished 4802 years before the two events took place.

NEW TEMPLE OF THE MYSTICS

Teleois circles indicate other dates also, given in what follows. To the outer world these may not be significant, but to those who know, they reveal the events of the journey of the Dalai Lama and his holy men, who left Thibet with him. April 27, 1922—glorification of shrine of the Son of Heaven in Japan; July 27, 1922—Temple of Northern Light; January 12, 1923—Mountain Temple of the North; October 23, 1924—sanctification of four masters in Europe; November 5, 1924—New Temple in Russia; December 13, 1925—in Jerusalem; August 17, 1926—hidden Holy of Holies in Ethiopia; February 2, 1927—Coptic Temple; May 4, 1927—leaving Africa for South America; June 25, 1927—arrival in the eastern Andes; July 16, 1927—consecration of the first stone of New Temple.

This change—from Thibet back to the eastern Andes, after many thousand years' absence—is the symbol of the reglorification of the Western World, the active participation of supremely great powers of good, activated to work with man to BUILD UP a new era, to let brutal power destroy brutal power, and to establish peace forever on earth! The significance of this Temple for you, is that all great advances come first by revelation from beyond the self. Whether in science, or flying, or hearing through space, or the guidance of the wise men—all come first by the power of spirit, and manifest by *'man reaching toward the infinite.'*

XXIII

MEANING—HALL OF ADJUSTMENT

October 22, 1929—May 5, 1931

The time period of this Hall of Adjustment—less than two years—is noted for hundreds of plans proposed for the adjustment of man's economic life on earth; plans to adjust the finances of nations; and tragic attempts of millions of individuals to adjust their own lives to the new conditions, due to the sinister effects of the Second World War—the War for Gold.

During this period man began to realize the uncertainty of all present means of providing security for the individual, or of attaining peace for nations.

The events of this period so closely parallel those of the *third* campaign of the War for Gold, that there is little need to repeat them here—so I again refer you to Appendix EIGHT—*The Gold War*.

With billions of money, limitless resources, tens of thousands of idle machines, millions wanting work, tens of millions wanting all the things men and machines could produce—*there was stark want!* In this condition man passed from the Hall of Adjustment into the Temple of Initiation—in which the ancient mystic wise men had prophesied, that new means of a new freedom would be initiated.

XXIV

MEANING—TEMPLE OF INITIATION

May 6, 1931—August 9, 1939

August 9 of 1939 was man's *last* day in this Temple, and you well remember what happened that *Fateful Day*, when momentous decisions were made at Berchtesgaden. Man's *first* day in this Temple was May 6, 1931. By greater use of vision lines than in other chambers, the wise men prophesied that *seven great world changes would be initiated* during the years 1931-1939 of this Temple. And the prophecies symbolized by dates built into the masonry structure of this marvelously beautiful Temple of Stone Veils *have come to pass!*

The FIRST world movement initiated in this Temple—the one most evident to us now—is the *Great World War of the Giants*. (The Pyramid symbols represent the dictators, as Giants of Power-in-Action.) This Third World War started in Central Europe on September 1, 1939. It was, however, initiated before the march into Poland—for it actually started in China and Ethiopia and Spain.

The aim of the First World War, 1914-1918, was *Dominance of Europe*.

The aim of the Second World War¹ was *Control of Gold*.

The aim of the first plan for this Third World War was *World Dominion!*

The aim of the second plan—adjusted in 1933—*Dominion of Europe-Asia-Africa!*

AMERICAS NOT INCLUDED

The second plan calls for unity of action of SEVEN supreme dictatorships; at first, five—Germany, Italy, Japan, Spain and Russia; with two others to be chosen, one for India and Oceania; another for western and southern Africa. In the first plan, the Americas were included, but this was later vetoed—first, because the Americas would be of greater trade-wealth value as inde-

¹ See Appendix EIGHT.

pendent democracies; and second, because The Giants desired a *compact area*, containing all raw materials needed, yet requiring no great navies to police intervening oceans (see a world map). The peoples of the five powers first mentioned above ARE bound together by similarity of ideologies; and no one of them can attain what it wants without the ultimate help of the others. No matter what the ebb and flow of adjustments, or pretended temporary severing of ties, or on which side any dictator may throw his armed power for a time—*these five are sacredly pledged ultimately to unite to dominate Europe-Asia-Africa!*

THE KALEIDOSCOPIIC CHANGE

The SECOND great world movement initiated in this Temple was the *amazingly rapid change in ideologies and modes of government. This newly initiated movement in government is the change from TALK to ACTION!* For 2400 years—by slow progress and continued struggle, and even by civil war—man had fought and died to attain increased human rights of individual freedom. It began with the early Greeks, and continued through the Middle Ages and post-feudal times, until finally man attained the Magna Carta, Bill of Rights, Declaration of Independence, and constitutions embodying the rights attained. By 1920, it had taken 2400 years of lofty idealism and great sacrifice. Then came the kaleidoscopic change with electronic rapidity—*in only 17 years, the 2400-year trend toward democracy was turned into a mass rush toward dictatorships!*

There is a reason: Democracies had attained *rights*, but they had not developed *power-in-action*. For fifty years they had been allowing *talk* to run away with them. Congresses were no longer Halls of Discussion. *They had become Personal Propaganda Centers for speech-making to win popular favor and advance personal political purposes of the members.* By 1920, democracies were so weakened by talk that they lacked the power necessary, to counteract results of disintegrating ideas, whose spread had been made instantaneous, then multiplied a hundredfold by new means of communication.

DICTATORSHIP EVERYWHERE

We must face the truth! ALL peoples turned to dictatorship—France, Great Britain and the United States, as well as Germany

and Italy and Japan and Russia. French Premiers were given autocratic power; Prime Ministers of the British Empire were given power to rule by Cabinet decree; and the President of the United States was given a score of absolute dictatorial powers. The excuse that such power is necessary in emergencies is more than an excuse. It is the truth that, under the new conditions of increased speed of all national and international action, there are always emergencies, and need of power to act quickly.

We must face truth. There would be no autocracies of brutal action, if democracies were not now weakened by too much talk. And unless man evolves a new form of democratic government before 1947, our talking democracies will be destroyed by the action power of dictatorships. And so, out of the new conditions, man is now evolving a new mode of democratic operation, with power of action added to possession of individual rights and freedom of discussion. With this attained, democratic government will have power to maintain freedom on earth!

THE CRY FOR NEW LEADERS

The THIRD world change initiated in this Temple, is the awakening demand² of millions of souls for a *NEW kind of world leader!* The world will not attain the goal man desires, until it is free of action leaders who are brutal, or talking leaders who initiate wars by deception. *The new demand is a spiritual awakening within the consciousness of man, and it is being wrought by a two-edged flaming sword!* This is revealed in prophesied Teleois dates, by the sign of a flame of spirit, reaching up out of acts of brutality on the one hand, and out of deception on the other. The prophesied dates of *violent* use of powers are: June 30 of 1934 and August 23 of 1936. The dates of twisted deception of peoples are: May 2 and December 25 of 1936; September 21 and October 7 of 1938; and March 14 and September 1 and 5 of 1939.

We quickly recognize the first—for June 30 of 1934 and August 23 of 1936 are, respectively, the dates of the Nazi blood purge in Germany and the beginning of the trials and later executions of high Russian officials. We know these and other similar acts so well, there is no need to give space to them here.

Acts of TWISTED DECEPTION have been more dominant, but, often being carried on under cover, have not been evident.

² *Training in Action-Leadership*, by Brown Landone, L-I.

Then also, lack of consecration to all truth makes man fail to see deception except where he wants to see it. May 2, 1936—Great Britain forgot sanctions against Italy, and left Mussolini free to do his will in Abyssinia. December 25, 1936—Chiang Kai Shek sold out his ideals and allied himself with Communists of northern China. September 21 of 1938—British and French officials³ secretly decided to abandon Czechoslovakia. October 7, 1938—eleven months before Germany marched into Poland, Chamberlain begged the House of Commons to support his Cabinet's plans for preparation for WAR; and asked members not to 'take seriously' what he said about PEACE to the English *people!* March 14, 1939—Hitler forgot his promise not to annex Czechoslovakia; and September 1, forgot his promise not to seek more European territory, and began ruthless conquest of Poland. September 5, 1939—France and England⁴ 'forgot' their pledge—which meant salvation or destruction to Poland—declaring it was not feasible to send even 50 of their 7000 war aircraft to Poland. Yet, exactly 56 days previously, July 11, England had sent 120 heavy bombing planes to *southern France and back without a stop*, and announced that she could easily send her heaviest planes to any place in Europe.

These events—of brutality and deception—like two-edged swords, have awakened millions to demand a new kind of leadership, less brutal and nobler and more honorable than the leadership of today, which—either by brutality or deception—ever leads to war! And the era of new leaders shall come before March 6, 1947!

MONEY FOR THE PEOPLE

The FOURTH great movement *initiated* in the Temple of Initiation was the establishment of a *new world money ideal*, based on the needs of workers and producers of the world. France had tried⁵ to make gold the basis of money to manipulate \$12,000,000,000 of bonds and securities of the world. Great Britain had used gold for 98 years⁶ to control the money market

³ Evidently this decision was more important to the wise men of old than the date of the Munich conference.

⁴ When it is sometimes said that England broke her promise, it should be noted that this was often the action of a Prime Minister, not due to the wish or will of the British people.

⁵ *Rise and Fall of the Gold Standard*, by Sir Charles Morgan-Webb, pp. 115, 131, 149-154.

⁶ *Ibid.*, pp. 150-151.

of the world—compelling all nations to use her money unit to determine value of their monies! Victory for the new ideal was attained in 1933, by the initiation of the use of gold to stabilize world *prices of the products*, produced by the work of hundreds of millions of people of all countries.

MYSTERIOUS CREATION

The FIFTH great world change initiated in this Temple is the beginning of man's *use of cosmic energies to transform the substances of earth!* In this Temple man *initiated the means of using cosmic energies to build up new substances!* In 1932, Joliot artificially created the neutron by bombardment of beryllium with alpha particles; positron was artificially created by use of cosmic rays by Anderson and Millikan; 1934, artificial radio-activity itself was produced ⁷—“*convincing chemical proof of the artificial transmutation⁸ of the elements.*” *This was the attainment longed for for ages—fulfillment of the dreams of alchemists—the chemical attainment of the secret of the Philosophers' Stone.*

YOUTHFULNESS CONTINUED

SIXTH, science for the first time in all centuries, itself initiated efforts to maintain and renew youthfulness of man's body. For 10,000 years man has dreamed of a continuing youthful body—yet he still begins growing old when 23 or 24 years old, and after that, continues slowly dying for the rest of his life on earth. The new movement was initiated by scientists, not by charlatans as in previous eras. We can now awaken brain centers to greater activity to free increased energy for the body; use catalytic foods to activate the endocrine glands; restore the responsive film covering of brain cells to give us great increase of spirit energy; regrow tissues almost limitlessly. We now know the substances which increase the holy *white inner light* of nerve and brain cells and increase vitality, virility and youthfulness; and we have learned to attain truly amazing results by use of lecithin and enzyme and auxinon foods. A hundred scientists are working to help man attain the goal. One biologist states that science ⁹ for

⁷ For eleven other related discoveries of these years, see *The Advance of Science*, by Watson Davis, p. 44.

⁸ *Ibid.*, p. 59.

⁹ *Man the Unknown*, by Alexis Carrel, pp. 321, 319.

the first time in history, now "gives us the power to develop all the potentialities of our body" and "the restoration of man to the harmony of his physiological and mental self will transform his universe." *Thirty-nine new discoveries prove the imminent possibility of body transformation.*

NEW TEMPLE CONSECRATED

SEVENTH comes the *initiation in this Temple of a New Spiritual Age for Man*, on the prophesied date of December 25, 1938. You remember that the 13th Dalai Lama was reported to have died in Thibet in 1934, but that instead he had previously left Thibet in 1922; his substitute had died, and he and his holiest of holy men had returned to the Andes. At four o'clock in the early morning of December 25, 1938, the consecration of the new hidden Temple of the Mystics in the high eastern Andes took place, by 91 envoys from 13 centers on earth. *This was the initiation of a new spiritual age on earth for man, whose power shall be felt before March 6, 1947.*

MEANING—HALL OF TRANSFORMING ACTION

August 10, 1939—March 6, 1947

The years we are living today—1939 to 1947—are symbolized in this Hall of Transforming Action. What has taken place and will take place in this Hall—the suffering of tens of millions and the tragic experiences of all the world—are so vital to us that I write of them in a subsequent chapter, so that I can give more space to this period, without interrupting the sequence of these chapters on the Meaning of the Temples.

This Hall is the Hall of TRANSFORMING Action. It is the time of transformation of man on earth, during which man must prepare ¹ himself for the transfiguration of all conditions of life. These will soon come to pass—both for man individually and for the world—in the Temple of Transfiguration.

This Hall is the hall of transforming ACTION. It is a time of action! In it man must learn that brutalized action brings reaction among nations, just as it does in individual life. Unless man discards brutalized action and attains peace for himself, and establishes peace among nations, the brutal action will destroy him, individually and *en masse*. Man's need of learning a new mode of action, by which he CAN make his ideals come true with never a failure, is so important that a book by itself should be given to the subject.

The ONLY action which transforms is IDEALIZED action. Long ago man learned to discard brutalized action in the family and in dealings with others individually. Later he substituted talk for action. Now, in this present period of man's evolution—from 1939 to 1947—man learns that *idealized action is the mode of power by means of which he can transform himself, transform conditions, transform the world!*

¹ *What to Do in These Years—Four-Fold Plan of Action*, by Brown Landone.

XXVI

MEANING—TEMPLE OF TRANSFIGURATION

March 7, 1947—November 22, 2000

Man will enter the Temple of Transfiguration, March 7, 1947. The time of man's development in this Temple will be almost 54 years. Fifty-four years ago, we still used oil lamps, and NO man on earth had ever listened to a radio, or flown in an airplane, or ridden in an automobile! When you think of what has taken place in the last 54 years, you can realize that the realities of the next 54 years may be greater than anything you now dream.

The beginning of the change will come quickly, and out of the war turmoil of the world, as suddenly as the sun bursts out in glory after a thunderstorm. It will be the New Era of Spiritualized Gold! You may not at present understand 'spiritualized gold,' any more than your grandfather would have understood the term 'broadcast by radio.'

A WORLD'S DREAM ATTAINED

FIRST, there will be a Government of the World, not by dominance of one or two powers, but by harmony of all! Our Third World War will have merged into a Fourth—perhaps with no intervening time, but with a new ideal to be attained. Out of it will come the Super State of World Peace¹ which shall have *power* to maintain peace, so that no individual nation shall ever again have power to disturb the peace of the world. The change to peace will come rapidly; man will be lifted out of the mire of lowlands shrouded in fogs, and actually lifted up to plains of bounteous plenty and heights of joy under the calm of stars.

SECOND, in this Temple of *Transfiguration*—after March 7, 1947—each soul on earth shall be a World Citizen. Man will move freely from nation to nation, and be welcomed as all good citizens of one state of our union are now greeted when they move to another. The conditions which through ages have led to

¹ *A Super State to Enforce Permanent World Peace*, by Brown Landone.

friction of boundaries and national hates, will disappear. The new world citizenship will be based on the brotherhood of man. Of this, the prophecy of the Order of Melchi-Zedek is certain as the stars!

THIRD, all national governments of the world will be changed. Whether they shall be democracies or dictatorships will not matter—for man in each will be free. Every totalitarian power which does not abandon brutalized force will destroy itself from within. Every democracy which does not rid itself of its talking weakness, will disintegrate. Each new government—purified in the Hall of Transforming Action from 1939 to 1947—will work in harmony with all others, and each will exist to bring joy to its people.

BODIES WHICH TRULY LIVE

FOURTH, *man himself will be transfigured!* Many individuals will effect this change *before* 1947, in the Hall of Transforming Action. Others may do it shortly *after* entering the Temple. But whether before or after, it must be done. Every body that is not changed, will slowly cease to be! This is neither threat nor decree of punishment, but prophecy. For just as a plant—when given more sunlight—either adjusts itself to the greater energy, or wilts and dies—so also man, surrounded by the greater powers of spirit, will make his body more responsive² to them, OR—if he is too stupid and lazy to do so—his body will gradually be burned out by the greater energy.

No person, however, need suffer this—for *man's body CAN now become responsive to the super energies!* Man is surrounded by all the spiritual and cosmic energies of the universe. Man's present body is like unto a piece of mud-colored glass, covered with soot and grease and dirt; only a little of the light of the soul shines through. *Man's body of tomorrow will be a purified structure, of such crystal clarity that all the glories of the rainbow of spirit shall manifest fully!*

Soon man will possess three to four times the energy he now knows—for as he becomes more responsive, more spirit will flow through his body more easily, with less fatigue. Then less structure will be torn down, and less sleep be needed for repair, and greater youthfulness will result. Some souls in all ages have attained this responsiveness to spirit. *In the Temple of Transfigura-*

² *Spiritual Responsiveness of the Body*, by Brown Landone.

tion millions will be transformed! Man's greatest need this hour is to consecrate himself to make mind and body ever more responsive to all higher powers!

RESPONSIVENESS is the KEY to attainment. From the crudest bodily expression to the highest state of spiritual consciousness, *every advance comes only as man makes mind and body more responsive to spirit!*

GROWING NEW YOUTH

FIFTH, *instead of growing old, man will grow young.* Fed with miraculous youth-growing foods, and activated by spirit, the cells of the body will reproduce younger cells. No scientist can find any basic reason for growing old, except the neglect of living youthfully. It is not here proclaimed that any one body will continue youthful through all ages, but the body *will* be renewed, and continuing youthfulness *will* be attained! The means are revealed. Science has lately discovered mysterious foods—chlorophyl, lecithins³ and auxinons. Sufficient lecithins can triple responsiveness of brain and nerve cells to spirit. More youth-growing auxinons can make old cells reproduce youthful cells. *In biological tests, bodies of decrepit old animals HAVE been transformed to more beautiful bodies. And human beings, naturally using these mysterious foods, have experienced changes to greater youthfulness!*

Then also, with new knowledge of the use of catalytic chemicals in growing plants, man is growing foods of new values, containing abundant supplies of chlorophyl and youth-growing auxinons, and these as foods increase the responsiveness of his body. Those who have already attained this joy of living—even at 90 years of age working, playing from 18 to 20 hours every day—are proof that such spirituality of body can be attained.

MIRACLES IN NEW THINGS

SIXTH, in this Temple, new things will transform all life for man. Your new homes will be illuminated by light radiated evenly from walls and ceilings—any color, brilliant or softened—rose tinted dawn, noon brightness, or soft moonlight—and cheaper than present lighting; and no need to press buttons, for rooms will automatically light themselves; or you can turn light

³ *Mysterious Catalytic Foods*, by Brown Landone.

on and off by *speaking* to a panel in the wall! Heat will be radiated from floors and walls, and regulated automatically hour to hour, year to year. Air will be cleaned and purified and delicately scented; no dust year in and year out.

I mention but a few of a hundred other new things—dishes of plastics, unbreakable, beautiful as emeralds and rubies and diamonds, and cheaper than the cheapest you now know; little 'talking and printing boxes' in every room—on tables or near your bed; when you awake in the morning, press a button and pull out a sheet of paper—news of the night printed for you moment by moment while you slept; or press another button, and listen to any musical program you may have missed during the previous day or night—from Paris, Berlin or New York. *Speak* to doors and they will open or close at your command; such means are already perfected—by a code word keyed to a sound apparatus, and the sound apparatus keyed to motors. You shall have teleconversation sets—talking to friends a mile away or 5000 miles away without interference. If you doubt these things, remember that *doubters of progress have always been wrong*.

WINGING THROUGH THE AIR

Airplanes will soon be as common as automobiles are today; no large landing fields necessary; airplanes mounting directly up into the air from flat housetops or lawns; airplanes made of plastics, amazingly cheap!

If YOU think all these things too fantastic to be possible, imagine what your grandfather would have said if you yourself—seventy years ago—had prophesied *what I actually did yesterday*. That is, late morning in New Jersey I climbed into the hollow belly of a metal bird which has a couple of wings, but they will not even flap. Yet that bird flew me almost 1000 miles to Jacksonville in Florida, in time for me to give an afternoon talk. Then I stepped inside of a *glorified wagon which rolled itself along* at a speed of 60 miles an hour to Winter Park in Florida. There I gave an evening talk. After that talk, I climbed inside another metal bird, which flew 1050 miles back to New Jersey, and I was in bed before sunrise.

If seventy years ago you had prophesied what is becoming commonplace to us today, your grandfather would have had you sent to an asylum. So today do not think that travel by rocket

is impossible. Practical scientists are already working on the use of rockets for human travel.

LIFE AS IN TIAHUANACO

In the Temple of Transfiguration will come a reorganization of human society. When we study the records of what the Tiahuanacans attained thousands of years ago—immense wealth, abundant plenty and culture for all, with leisure compulsory—we feel ashamed that we, with all our boasted knowledge and science, still have a human organization so inefficient that, in the midst of billions of plenty, tens of millions of human beings have not enough to meet the actual physical needs of the body. *But before March 6, 1947, this will be changed!*

MESSAGES—MIND TO MIND

Then too, man will be spiritually transfigured! I might write of the strange communicating power—telepathic power—of ancient Tiahuanacans—so general that written language was not needed by them. For years we have discredited this power, so little known to most people. But today scientists are proving that it is a normal capacity of the soul. The attainment depends only on the degree of responsiveness attained. There is no reason why your soul cannot be as conscious of vibrations from a distance as that 'little box' in your home responding to vibrations from a thousand miles away. You call such a box a radio set. If such a *box* in New York can be responsive enough to receive vibrations from London, may not your brain be responsive enough to receive vibrations from a mere three thousand miles away?

YOU ARE GREATER THAN 'THINGS'

Personally, that which amazes me most in man is that he thinks that he is far below and much less than the things he creates. The creator IS always greater than the thing created; and you are greater than all things man creates! All comes first from God, or Infinite Energy—or whatever you desire to call the Supreme Intelligence. There is now scientific proof of divinity. I have already told you of designs inside of snowflakes—designs of things which man has actually created—telephone sets, chairs,

anvils, houses, cuff buttons. Divine intelligence—which conceives all things—implanted these designs in snowflakes, just as it inspired the same ideas into the minds of men, so that man would think of making them.

Man's spiritual transfiguration in this great Temple—during the years from 1947 to 2000 A.D.—will reach heights now known only to mystics. The *immensity* of this spiritually spiritual change is symbolized in part by the change in the time units used in this Temple. All time-spaces of all other Temples of the Pyramid are based on the earth's 365 days of circling around the sun, 92 million miles away. BUT in this Temple, all time-spaces are based on our solar system's 9,433,000 days of circling around a star center, 3,233,000,000,000,000 miles away! The increase from 92,000,000 miles to 3,233,000,000,000,000 symbolizes the INCREASED spiritual power man shall attain soon after March of 1947! *In this Temple of Transfiguration, man will become so much more responsive to the Infinite than he is today, that he will hourly KNOW that he is ever living and moving in the very being of the Infinite. And by 2000 A.D. he will be ready to enter the still unopened Temple of Godhood!*

XXVII

MEANING—TEMPLE OF GODHOOD

November 23, 2000—December 31, 2103

There are other Temples in the Pyramid of Gizeh, not yet opened. One of them is the Temple of Godhood. It is built to the time-space of a different kind of year—the year of the universe—which astronomers call the anomalistic year. Archeologists—working without spiritual guidance—have not yet discovered where the entrance is, for it is closed with a great block, perfectly fitted. This entrance was sealed 91 days before Khufu died in 2877 B.C.—that is, 4817 years ago.

The designation of the block and *how* to swing it open will NOT be revealed by the Priests of Golden Radiancy until man reaches the Altar-Ark, in the year 1997.¹ This will be almost 79 years after man of this age was first shown the Boss in the Temple of Revelation, and 79 years after the Holiest of Holy Men left Thibet to return to the eastern Andes.

At present, only a few mystics know where this Temple of Godhood is located in the Pyramid. Yet the very definite data of the Halls and Temples which we do now know reveal four facts: first, the location of the sealed and hidden entrance to the Temple of Godhood; second, the direction and distance from a given point in the axis of the Pyramid, to the hidden Temple itself; third, the dimensions of the Temple, exact to 1/100,000 of an inch; and fourth, the number of its anomalistic years. These are revealed to be equal to the side of a square the area of which is equal to the area of a circle whose circumference in number of inches equals the number of days of the *solar* year.

ANOMALISTIC AND LIMITLESS

The years IN the Temple of Godhood are, however, anomalistic years—the year of earth in relation to its universal center. This anomalistic year symbolizes man's *spiritual expansion be-*

¹ In a typewritten form issued early in 1939, this date of 1997 was mis-typed as 1947. The *correct* date is 1997.

yond the things and conditions not only of earth but of the entire solar system—it symbolizes man's spiritual expansion, even beyond all imaginable limits of the conscious mind. The Teleois of width to length to height of this Temple of Godhood are as 13 to 19 to 31; these resolve to 4 to 1 to 4—symbolic of power of dual creation, to create as *man* creates, and as *spirit* creates.

There IS hope for man today, and certainty of attainment. Everything in the Hall in which man struggles at present—that of Transforming Action—promises that man shall attain *today* the spiritual capacity of using the transforming action symbolized. This is the miracle-working power—by which man CAN turn desiring prayer into actuality. This prepares man for the Temple of Transfiguration and a new age on earth, during which “*the steps behind the rosy stone which is behind the stone that swings like unto the sun,*” will be opened, so that man can mount to the Temple of Godhood!

XXVIII

THE SEVEN GREAT POWERS

In our Sacred Scriptures, in the account of Creation, the word meaning God is a word in *plural* form—El-ohim—which means the *God of seven powers*. As man has evolved upward, civilization by civilization, seven powers have been dominant—one after another. These are the same powers as those symbolized in God's seven days of creation. They may be called the seven powers of creation. And they are the powers each *individual* must use, if he continually progresses from attainment to attainment. They are symbolized in seven Halls and Temples of the Great Pyramid.

The **FIRST** is the power of the first day of creation. It is the *expanding* power of God and man—of you and me—and of all the universe. The Tiajurans worshipped this power in their Temples of Radiance. In one age, the Temple of the Sun-in-Gold; in another, Temple of God-in-Gold. Jesus called this power the *Ouranos* power of the soul.

The **SECOND** is the dominating power God used during the second day of creation, the *uplifting* power. The first power merges into it. It uplifts matter, gives it life. We might say that it is the power which makes a seed sprout, and lifts it up to become a plant. This was worshipped by the Caracolians in their Temple of the Stars. In India, and later in Thibet, this power was called the Apherian power.

The power of the **THIRD** day of creation is the *forming* power of God. Ancient Egyptians worshipped it. It dominated all they did, hence their structures were built in solid form. They called it the Mathonian power. And the root of that word—math—from its hieroglyphic sign has come down to us through many languages. We find it in our word mathematics. This was the God power of the third day of creation, by use of which God gave *form* to the waters and *form* to dry land.

The **FOURTH** power, as of the fourth day of creation, is the *purifying* power of spirit or energy. It eliminates and throws out all that hinders the higher development. God used it on the fourth day to create light, to purify life and throw out the dark-

ness of existence. This power dominated the civilization of ancient Cathay, and was worshipped in its ancient Temple of Heaven.

The power of the FIFTH day of creation—and of the fifth great civilization—God used as the first recreating power, to harmonize and unify non-living substance with life. It was worshipped as the *harmonizing* power by the early Eleusinians—that is, before their concept of it was degraded. Jesus redeemed its spirit, and called it the Eleos power—as in “I will have mercy (eleos), not sacrifice.”

The SIXTH day of creation is dominated by the power we call life. It is the *creating* power which reproduces in its own likeness. It is the *Qodesh*¹ power of Melchi-Zedek; the Tisonian power of the Thibetans. It was worshipped in the Holy of Holies at Jerusalem.

The SEVENTH power—of the seventh day of creation and of the seventh great civilization—is the power which *rests* in realization that all is created of God. It is the *cosmicizing* power. It will become dominant in our civilization. Its power is already impregnating our minds; from the scientific standpoint, we call it cosmic rays; from the religious, spirit. The rays are but minor manifestations of the supreme cosmic spirit. Response to this, will lead man to union with God.

All seven powers have activated each civilization—just as all of them must be used by each individual to attain his highest development. But in each civilization, one was more dominant than the others. Today, we are longing to become more like God, not only in thought but in *action*. As soon as we become more spiritually responsive² to the seven powers, *we shall possess the power of transforming action, and be able to change all things.*

CIVILIZATIONS COME AND GO

Civilizations live and die. There have been six great waves of civilization; another—the seventh—is now here. Each of these waves include many sub-civilizations. Of these there have been many. Along the Euphrates and around the Mediterranean, one marvelous culture had followed another. Gorgeous Babylonial Egypt, with its great thinkers and builders! The beauty of the

¹ The Hebrew phrase translated “Holy of Holies” is *Qodesh haq Qodashim*.

² *Spiritual Responsiveness of the Body*, by Brown Landone.

sculpture and architecture of ancient Greece—unequaled today! The poetic genius of the Jewish herdsmen, and the magnificence of the private palaces of the Judean men of wealth and position—for example, the city home of James and John, who were not poor but immensely wealthy apostles of Jesus. Their palatial home was a structure large enough to cover blocks of a modern city, with wooded courts inside, streams brought underground to ripple through its gardens of rare tropical plants and trees—all inside the structure. And Moorish buildings in Spain—warm and cool air to every room; purified and perfumed. The culture of Alexandria; the temples of the northern coast of Africa; the classic buildings of old Rome and its stone roads throughout the then known western world!

Yet all so quickly gone! The fall of Rome—and then the 1000 long years of the Dark Ages! Loss of art and science and beauty and grandeur! A return to savagery so low our histories do not even mention it.

For us, however, there is great hope! We live while a *NEW civilization is being born!* We have more than the promise of its attainment, for *we are now in its Hall of Transforming Action.* *If we but learn its lesson now; if we but learn how to transform our thoughts and desires and ideals into actualities—then man shall possess the power to transform earth to make heaven on earth a reality!*

OUR DECISION

Transforming changes are taking place. We have need to choose wisely, to live to the highest. The holiest of the holy and the wisest of the wise men of Lhasa left Thibet because they knew that warring strife would come to Europe and Asia. They have been preparing a new holy center of four Temples, including the new Pyramid—in the Americas—to help us unify the mystic power of the East with the practical action of the West, making the material, ideal!

We of this generation are called to make the most important decision made by man since the fall of the Roman empire. That empire was followed by one thousand years of Dark Ages. What happened, can happen again! The conflict of Asia and Europe will spread to Africa; perhaps to the Americas. The war conflicts of our day will—unless transformed—result in destruction of most of our civilization. This need not happen. Man has today

the power to change himself, and the conditions he has created. He is now given the opportunity in the Hall of Transforming Action to make himself ready, by March 7 of 1947, to enter into a transformed world.

“A step is not a stair; yet each doth take thee nearer to the top.³ Stop not upon this one, or that—the first, or fourth, or tenth—but mount each step in turn, and thou shalt certainly attain thy goal.”

³ *Deep Down in Your Heart*, by Brown Landone, p. 164.

XXIX

YOU AND TODAY'S TRANSFORMATION

August 10, 1939—March 6, 1947

Living at this time, the years 1939 to 1947 are of present importance to us. Hence I add this chapter on the Hall of Transformation because of *its present significance, and the value of its guidance to us today.*

Many symbols in this Hall positively prophesy that 1939 to 1947 are the years in which nations, all economic conditions, and even man himself will be transformed. These changes start with a transforming war action, and you remember that the first day of this Hall began at midnight of August 9 of 1939—that fateful day when Hitler made decisions which initiated changes which will transform nations and the lives of hundreds of millions of people. *Then next, the prophecy reveals that this war will be followed by or merged into another war, and that the conditions of permanent peace will be initiated before March 6, 1947.*

This symbol of peace, however, is *preceded* by the symbol of transformed man; and the symbols of man and his transformation occur more frequently and prominently than any other symbol. Hence, the prophecy indicates that man must change himself before he can establish peace. The prophecy is definite: to truly live in this new age, man must transform his body to attain continued youthfulness; to transform his bodily tissues, to respond more fully to higher energies; transform his mind, to be able instantly to commune with others far distant; transform his attitude toward others, to establish a practical brotherhood of man. And that unless he makes these changes man will kill off man, until this civilization is destroyed.

In reading every sentence which follows, keep in mind that *transforming action* is what the Pyramid prophesies is necessary for man to change himself and preserve civilization. ACTION is the great need; and we marvel that *the prophecies tell us what is wrong now, and why, and what to do; and that all problems—*

international to personal—are linked up together; and that nothing but action, and transforming action, will solve our problems.

We have many problems to solve!

We have so much of everything that millions can not get enough to eat! And our automatic machines now produce so rapidly that man will never again be able to earn his living by the kind of work he has done in the past. Man must find a new kind of work to do to make a living, and hence he must change himself to be able to do it. And lastly, our serious problems of democracy and tragic world conditions must be solved. We cannot go on from war to war without wiping out, destroying our present civilization. All of these resolve into your problems and my problems—of what we can do and should do. And remember, the change must be made by *action*, and by action which transforms both men and conditions.

THE REVELATION

The Pyramid prophecies definitely reveal this by its Teleois symbols, and these symbols have meaning, as certainly as our signs \$, I, ?, have meaning. Pages could be given to these symbols and dates; but to learn what is wrong, and why, and what to do is more important—to help us restore power to democracy, change economic conditions, and attain world peace. So I briefly discuss only a few symbols, although in this Hall there are forty-seven mathematical signs which prophesy conditions today, their causes, and how to transform them. These symbols were built into the structure of the Pyramid 3947 years before either Germans or English existed as distinct peoples. I have here space to reveal only two. Study them, and then decide if the prophecies of long ago are coming true today.

First, in one group, there are symbols of *weakness*, and of *freely changing* groups of *man-masses*, and many, many *sounds*, and *action* signs diverging and never meeting anywhere! Is this true today? Freely changing masses of man exist only in democracies. Much sound—talk, talk, talk. Weakness due to talk; with no focus of action-power anywhere. That IS a fair picture of democracy, today.

Second, in another group, the symbols of *mass-sound disappear*, when they are *under action* symbols, which *focus* powerfully at four points. This also IS true today—mass-sound—discussion of

the masses has disappeared, under action, when it is focused in four powerful dictatorships.

These prophecies do reveal conditions and causes of conditions, today: dictatorship is powerful, because of suppressed discussion and focused power; and democracy is weak, because of divergence of power and too much talk. These are CAUSES of world conditions, and they are *the* causes of our economic conditions and that of the individual.

THE LOST POWER

Man has changed! From the prophecies and conditions about us, we want to learn what the change is, and how it has produced our present conditions. Only then can we change things to what we desire them to be. The change in man must be tremendous. Something has happened which seems to make it impossible for man in these later years to carry his desires into realities—otherwise, with all our resources, millions would not be in want; and with hundreds of millions desiring peace, we would not be having one world war after another.

There has been loss of power! Today man talks too much about what is to be done, and fails to do enough to change conditions—witness, economic want, and wars!

What has happened? Most consciousness of power and capacity to do things was built up by ages of action. And it was centered largely on one kind of action which became a dominant habit.

Man built up one mode of action as his most dominant habit.

Man spent 800,000 years¹ building up that power of action!

It was dominant, and the basis of all consciousness of his own power.

Then, it was taken away from him in only 50 years!

That loss is the most amazing change in all of man's activity on earth. That loss has led to most of the international, national, economic and individual problems of today. *Its loss actually endangers all democracy.* And unless we find a way—and find it soon—of restoring this power of action to all men, a very few men will unify their power and all the world will be under dictatorship, until the dictatorships destroy each other, and us with them.

¹ Moir's excavations prove that man began making polished flint tools more than 1,000,000 years ago.

The next few paragraphs reveal how man built up his consciousness of power of action, how he lost it, and how it can be restored. Read this a hundred times if necessary, clearly to see what must be done to restore this power of action. Such restoration is necessary, not only to make your life worthwhile, but to continue civilization. I take up, step by step, how man built up his consciousness of power to do things; what took it away from him; the effect of that loss on his activity, brain functioning and entire outlook on life; then what he substituted, and the effect of the substitution on man himself and on all the conditions around him—economic and world affairs; and lastly, the solution which is simple and certain, and prophesied by the wise men of old. Read the following thoughtfully and prayerfully, many times—for nothing but transforming action can save us now.

WHAT POWER WAS IT

Since man first started making flint tools, practically *all of his action of 800,000 years* was expressed in getting what he wanted by brutal force, or in producing things he wanted to use. His brutal fights were intense, but soon forgotten. But months of time and effort were required to make the first flint arrowheads. *In such activity, man united desire, interest, longing and patient thought—all carried into action.* Hence, it was the PRO-DUCTIVE activity of man which during all ages built deep pathways in his brain. Because of this, it was man's productive action which became man's *one dominant action-habit!* And it was that habit of action to make and do things which gave him his consciousness of power! And remember now, that this was ages old—at least 800,000 years; and that man had developed no other habitual basis of power to do!

WHAT TOOK THE POWER AWAY

It was not the machine of 100 years ago which deprived man of the use of productive action. It was the more recent automatic machine. For fifty years, it has been gradually depriving man of his productive action in making things. Such machines are now supplanting even his thinking. Yes, thinking! A machine in the California Institute of Technology can do more complicated mathematical calculations in 20 minutes, than an expert mathematician could do, if he lived 310 years.

Please realize more fully the effect of this loss on neural system, consciousness of power and entire attitude toward life. When 800,000 years of habitual productive action was STOPPED in 50 years, it produced the greatest brain inhibition man has ever experienced. Every cell of man's brain and nerves—and muscles also—had been habituated for 800,000 years to that one dominant activity. Then, in 50 years, automatic machines deprived man of that mode of action.

Compare the effect to something you can more easily imagine. Think of an athlete who has been active every waking hour for ten years. Then in one minute he is stricken, partial paralysis, able to move only a little! Imagine the effect on his brain, still exceptionally active; and the effect on his mind and emotions; on his entire outlook on life!

MAN SUBSTITUTED TALK

With this momentous change—man's lost opportunity of using his one dominant action habit—man did not know what to do. His mind was still creatively active. He could not stop thinking. He had to express himself in some way. So, deprived of his one dominant mode of action, *man turned to talk!* And ten new talk-inciting inventions led him on, to talk more and more. At first, it seems incredible that men of action became mere talkers. But what else could they do? When deprived of the one means he had used for ages, talk was the only substitute available.

Because of this dual change—loss of action and increase of talk—both man and human society have been changed. Man was once the action-unit of human society. Now he is a talking-unit! This gives us a KEY to the understanding and remedying of most of our problems of today. Everywhere we see the tragic result of too much talk and too little action.

EFFECT ON HUMAN SOCIETY

Once our men were effective motors. Now most of them are phonographs. And with this change, man has been trying to solve all problems by talk. We have talking reformers and talking congresses; talking advisors and talking executives. For ten years, a thousand men—minds of industrial giants, as well as many crinkly-cracked brains—have been telling us what ought

to be done to remedy our malfunctioning economic system. Salves and hot-water bottles have been applied to give momentary relief! But no one man of our 130,000,000 population has DONE anything actually to start ACTION of our factory and human machines, in such a way that our plenty would not mean starvation.

Man knows that talk is not a substitute for action. He wants actualities; he knows that talk never produces actualities; he knows that nothing but action can produce actualities. Yet in business and all public affairs, man is still concerned with TALK—written directions, sales letters, instruction sheets, consultations, reports, conferences, public speaking, propaganda, talking peace conferences, wordy diplomacy—ALL TALK.

Man's loss of productive activity has affected all phases of his life, and all groups and organizations of which he is a part. Instead of governments of action, we now have talking legislatures and congresses which take six months to do what might be done in three weeks! *Democratic governments have become broadcasting stations for spreading personal propaganda to promote the welfare—not of the nation—but of the individuals of legislatures or congresses!*

Hence, we have dictatorships. For if democracies had not been too weakened by talk, to solve present economic problems, no present dictatorship would have been established. And we continue to have wars upon wars, because we have not found a means of using idealized action to prevent them. Today, 400,000,000 people want peace and *talk* of peace—but are so weakened by talk that they are powerless to prevent war, when it is desired by a few men of action.

The prophecies of the Pyramid could not be more divinely true. All conditions of today must be transformed; they cannot be transformed by talk; they must be transformed by action; and they must be transformed now. *That is why this particular revelation is of such inestimable value to you, today.*

THERE IS A WAY OUT

If we can find a way of restoring action-power to individual man and to human society, then 90% of the talk of today will cease, and twice as much will be done in one-fifth the time. But we cannot restore action power by talk; nor by use of machines. Man cannot go back to producing things by hand.

Man must go forward, and there is but one field—the relation of man to man!

There is no longer an 'if' as to the possibility of action power being regained. It can and it must be. Never in any age has man been promised so much as in this Hall of the Pyramid. *In these seven years man's lost power of action is to be restored to him.* This gives us sane hope and confidence that things will be changed. This restoration of action-power is *more important than a score of wars and peace conferences*—for only by this restored power of action will man ever be able to establish permanent peace!

The solution itself is simple, but it is also difficult because of the man-factor. After years of increasing talk, most men are now talkers. And they find that talking is easier than action. Hence, the difficulty. Yet, machines now produce the things man needs, and man cannot return to action in that line. Man must accept the inevitable. Since he cannot compete with machines in producing things, he must give up trying to make a living by making things. *He must find some new need of society which requires all the action he can give!* In rendering mutual service one to another, man stands supreme, for machines cannot render *mutual* service, man to man. Hence, man's great opportunity of this age lies in mutual service.

SERVICE AND ACTION POWER

In this new age, man's service one to another will increase a hundred-fold. It will produce wealth immeasurably greater than making things. *And still more important, mutual service will be the means of RESTORING action power to human society. ACTION must be the basis of mutual service, because man will not tolerate being served merely by talk!* This leads to the next step. To organize a new economic life on the basis of service, based on action, we shall need millions of action-teams, just as fifty years ago we had millions of working-teams (instead of assembly lines), with each team under an action-boss. Each team of the new work of mutual service will require a leader. And now hear the angels sing! *Such leadership will restore consciousness of power of action.* Both the need and opportunities of action leadership are here; its rewards are immense; its fields limitless. See Appendix NINE—*Action Leadership*.

This will change ALL present conditions, but the transforma-

tion must be effected by action, and this will begin with the individual. Man will again become conscious of power to do, when he learns and applies the law that *each thing produces after its own kind*; that thinking produces thoughts, visioning creates visions, life reproduces life, and that nothing but action produces actuality. Whenever man produces in actuality what he desires, he becomes conscious of power. It is talked of desires, unrealized, which create consciousness of failure. Long ago, man idealized thought; now he learns to idealize action. Thus he will transform himself. And when millions so transform themselves, all conditions of earth will be transformed!

TALKING LEAGUES AND WAR

Since this message is written for YOU, I deal with international, national and economic conditions, *because you live on earth in the midst of these conditions and your life is affected by them.*

Our greatest world problem is the establishment of permanent peace. We all want peace; we have organized and striven for it for three generations; we have failed to attain it. Our failures have been due to the means used. Peace organizations—whether a peace society or an international congress or league or union of nations—*each one of them has depended on TALK as the means of establishing peace.* Until² the present year, no peace movement based on action has been organized. All others—since the Holy Alliance 125 years ago—have depended on discussion to secure peace, and their efforts have always evaporated in talk, or led to disagreements and friction and more wars.

The greatest mistake in internal efforts of our century is the very mistaken belief that discussion in League Assemblies and Federal Union Congresses is the way to peace! Every time this means has been tried, it has led to new wars, because there is a peculiarity of peace or war, which will not admit of discussion. There is NO need of any federal union or league assembly to discuss whether we want permanent peace, or whether we prefer a world war now and then. We know we want peace; we know we do not want war. NO discussion is necessary.

When there is no need for discussion, there should be no discussion. And whenever any world congress discusses a subject,

² *The Peace Makers* is organized to attain peace by the power of prayer and action—The Peace Makers, National Center, Winter Park, Florida.

which needs no discussion—the result is differences, dissension, opposition, withdrawals, and then more wars. *This has been the history of every league or union congress concerned with peace!*

Wise leaders and thinking men have learned the lesson. This is the age of transforming action, and although the mere talkers still want us to establish new federal unions and world leagues—talking world congresses which will again lead to more wars—the higher spiritual concepts will prevail, and we shall, by transforming action, establish a new kind of Super State, based on idealized action to establish and maintain peace. Peace shall be established by the transforming *action* prophesied in the Pyramid. Soon we SHALL have a SUPER STATE³ with POWER to enforce permanent peace.

TRANSFORMED DEMOCRACY

And our *democracies* shall be transformed. All weaknesses of democracy at present are due to talk, so much talk that action is impossible. For example, in the United States today, there is now so much talk in our federal government, that it would require four generations—grandfather, father, son and grandson—merely to read the talk and related governmental papers and reports of one session of the U. S. Congress.

We must transform democratic government.⁴ The *people* must be given more opportunity for free and frequent discussion to determine public policies. The talk of the government itself must be restricted, and given more power-of-action to carry out the policies determined by the people. With these changes, autocracies will disappear and democracies will be strong enough to maintain the will of the people. See closing sections of this Chapter and Appendix NINE—*Action Leadership*.

OUT OF WORK

Then too, *economic conditions* will be transformed. The ten years 1929 to 1939 have changed the lives of all of us. *The great problem of today, of how men will be able to earn a living in the future, is still unsolved.* Machines are increasingly multiplying production of all things, with less and less man labor. The

³ *A Super State with Power to Enforce Permanent Peace*, by Brown Landone.

⁴ See *Omnocracy*, Booklet VII of *The Order of the New Adjustment*, by Brown Landone.

claim that, on 'the long pull,' each new machine¹ creates more jobs than it destroys, might be consoling, if we did not now know that it takes eight to ten years to make such a change! And we cannot afford to support 8,000,000 to 13,000,000 unemployed for that length of time, whenever there is a new advance in the use of new machines.

The key to the solution is found in this sentence: *We have such an abundance of 'ultra comforts' that millions are in dire need of the 'necessities' of life.* The great upset has come because of the 'turnabout' of the respective demands for necessities and ultra comforts.

Once man worked practically all of the time to produce the necessities; he had to; it took so long to produce them by hand. But with our new automatic machines, man can NOT secure continuous work in producing necessities; and capital can NOT make a continuous profit in producing them. For example, consider the 11 men who operate a modern oven, baking 35,000 loaves of bread a day. That bread sells at 10¢ a loaf. Before a group of workers can get enough buying power to pay for those 35,000 loaves, they must—in some way—get hold of 35,000 *dimes!* That is \$3,500. And NO company can afford to pay those 11 bakers \$3,500 a day for their work—that is, \$318 a day to each baker. Economists make evasive excuses—they talk of other workers employed in making the bread, and insist that workers in other industries will earn enough to pay for the 35,000 loaves. But years of bread-lines prove that there is a gap somewhere. *And in all other industries using automatic machines, the condition is the same as that of the automatic bakery!* The few workers needed cannot be paid enough, to create sufficient buying power. Machines now eat up that buying power.

THE DEEPER CAUSE

The trouble⁵ goes deeper! Usually, the more a human being has, the more he wants. But necessities of life are strangely non-human. *When your wife or daughter has eaten a peck of potatoes a week, you can not make her eat any more. Her demand for potatoes is limited.* This is true of all necessities of life—but only

⁵ *The Order of New Adjustment*, 7 bklets: I—Do Something Now; II—A Changed World; III—Vision of Things to Be; IV—Desire for New Things; V—Provide Necessities of Life for All; VI—Action-Leadership to Stabilize Us; and VII—Omniocracy; by Brown Landone, set of 7, 50¢.

of necessities. The old system of producing necessities will not work any longer. Machines, not men, do the work; but it is men, not machines, who need the bread.

There IS a solution ⁵ fitted to a democratic society, based on individualism. It provides increasing employment, with increasing wages for all workers. It separates necessities from ultra comforts and luxuries. There is a limit to the demand for necessities. But there is no limit to the demand for ultra comforts, because man's desire for them knows no limit. Please see my seven booklets, *The Order of New Adjustment*.

Settle necessities first: *We can no longer make continuous profits out of producing necessities*. So let machines, operated by photo-electric cells, produce the necessities of life at almost zero cost, and provide the necessities of life to all people needing them, so that there shall never again be want in our land. This would cost us only 5% of what we now pay in taxes to take care of unemployed, and what we lose because of shutdowns and strikes.

LIMITLESS EMPLOYMENT

And then let us—as individualists—turn to producing, and advancing the use of, the ultra comforts and luxuries of life. *This is the only phase of production in which man can make continuous profits*. Every industrial fortune of the last fifty years has been made in ultra comforts and luxuries. In producing such things, we give man the opportunity of a higher, ever-expanding life—with work increasing, wages increasing—because man's desire for such things is limitless, and consequently, there is NO limit to the economic demand for them.

The true basic solution lies in ADVANCING THE USE of ultra comforts. Since man can no longer find enough work in making things to make a living, he must turn to service for income. There need be no fear of not being able to earn an abundant living in the new age, for there is NO limit to the service man desires or desires to render. The silliest economic thought today is that wealth depends on things. Not one thing on earth has any wealth value, unless it is of service to man. Wealth resides in service. And man's service is the greatest source of wealth on earth. Out of mutual service will come greater wealth than man has ever produced by his labor in producing things.

Because of our machines, mere production of ultra comforts

and luxuries might not prevent unemployment; but *the service of advancing the use of all such things is limitless*. In this, all human society can be employed, and in action units. Mere wages are paid for making *things*, but much higher salaries are paid for *service*. There is more wealth in exchange of mutual service than in exchange of mere things. *This transforming age of mutual service will initiate the fulfillment of Christ's prophecy of the brotherhood of man!*

We can now, without fear of being deprived of a living, view the miracle working new processes and things—now all ready for us to use—in this Hall of Transforming Action. The age of burdensome labor is passing; the age of continuing cultural enjoyment of life is being born.

MIRACLES OF PRODUCTION

The photo-electric cell works miracles by operating machinery. One factory—with only a few men—can turn out twice as many automobile chassis as all our automobile manufacturing companies could use at highest rate of production, running full time. Flour mills, with eight men and the new machinery, can grind all the cereals needed by all the population of our country. In a new bakery oven, each baker can bake 3181 loaves a day. A knitting machine, producing sheer knitted silks, can take as many stitches in *one minute*, as the fastest woman knitter can take in *six weeks!* Cloth can be printed direct from chemical liquids—no spinning, no weaving. There is already similar production in 103 other lines.

The photo-electric cell is the one great miracle of this century. *It now has productive capacity equal to that of one billion workers*—greater than that of all peoples of Europe and the Americas. It needs no rest; never eats, never tires, and never asks for wages. It is already in use in sixty-nine industries, and hundreds of factories. *Man shall now live; not merely struggle trying to get enough to exist.*

Also, there are amazing new opportunities of new wealth. Man can grow miracle plants—with use of trace chemicals—twice to twenty times as rapidly as in the past; transform the chemical nature of the plants; produce foods of new values; and grow other plant growth—for beauty and for materials. These new fields of new wealth offer new and almost unlimited opportunities.

RAPID PLANT GROWTH

We have seen the transformation take place: lettuce in pots, growing 455% more leaf surface than lettuce grown without the rapid growth chemicals; Mung Bean sprouts, ten inches high in four days, rich in the newly discovered *auxinons* which—as foods—tend to increase new youthful cells in the human body; rhododendrons, leaf surface increase, 456%; cotton leaf surface, 5717%; tomatoes, 430,000 pounds per acre; a fern putting forth 52 new fronds in 9 days—the new fronds growing 10" per week; an OLD rubber plant—long past any youthful spurt of growth—increasing its height rate growth 2073%—like an old man of 80 years become young again! No more aging of body and dulling of mind by too heavy labor on the farm. With use of trace chemicals, farm work will become creative—producing new values in foods and new kinds of materials.

Man has only begun to work the transforming changes which will meet all the economic wants of man. If man organizes his activities to co-operate as harmoniously as beavers, as intelligently as squirrels, and as justly as ants—a heaven of plenty on earth will be attained. And this is prophesied to come to pass before March 6, 1947.

MEATS GROWN IN VATS

Growing meat in vats is on the way. In his laboratory, Dr. Carrel started with a tiny piece of heart muscle, and kept it growing continuously for 28 years. It was a biological miracle. Now I vision it economically. If all of the growth had been kept up to 1933, and had been kept growing—enough heart meat would have been grown to cover 14,000 acres of land an inch thick! That is enough for inch-thick steaks for 9,757,440,000 people! This is the prophecy of growing any kind of meat in vats—any quality, any texture, any flavor, any taste desired.

This IS the time of transforming changes. Those mystic wise men of old—High Priests of the Order of Melchi-Zedek of 4821 years ago, saw clearly what would happen today, and their prophecies are coming true!

THE CORE OF ALL

Now I come to you! The coming miracle of miracles will be man's transformation of himself. You will attain new youthfulness. Science now confirms the possibility. "I have found a remedy for old age," announced Dr. Voronoff at the 28th French Surgical Congress in Paris; and Dr. Alexis Carrel in his *Man the Unknown* announces that science has now provided the means by which man can transform human life. "You can change⁶ the dying processes of your body, to a youth growing process."

You must, however, do more than mentally stimulate yourself to act as though you were young. Merely thinking that you are young is not enough. Trying to believe that "one is as young as one feels" often means that you are "pretending to appear to be as young, as you pretend to feel." The key to true youthfulness is the degree of your body's *responsiveness* to spirit-energy. For this, there must be a change in the living substance of your body, an increase of your love for its cells; and *an increased rate of activity!*

GROWING YOUTHFULNESS

Substance of structure CAN be changed, and organs also. "In one test, in which worn out old animals were fed for a few months on immature foods, shrunken organs were restored not only to activity, but their form and structure were increased to normal size."⁷ We have now discovered the amazing value of lecithin and auxinon foods—catalytic foods. A catalyst⁸ is a substance which increases the activity of other substances 1000 times, or 1,000,000 times, or even 10,000,000 times. Such substances can work actual miracles in your body.

But responsiveness to higher energies and increased activity are also important. The evidence is certain: *slow action is a destructive process*. Drive your automobile for three days at 8 miles an hour, and it will be torn to pieces. So with man—the slower your activity, the more it ages the body. Joyous speed-up of action activates inner glands, and then tissues are rebuilt, and respond in new youthfulness and increased energy. By increased

⁶ *Mysterious Catalytic Foods*, by Brown Landone, L-V, p. 33.

⁷ *Mysterious Catalytic Foods*, by Brown Landone, L-V, p. 31.

⁸ *Soul Catalysts*, by Brown Landone, pp. 7-12.

and greater responsiveness to spirit, and with increased activity—you approach the very nature of spirit! *Such a transformed condition is like unto spirit*—for spirit is forever youthful, never tires, has constant endurance, and is joyous in action.

YOUR NEW FITNESS

Your FITNESS to live comes next, for we have already entered the years of Transformation, 1939–1947. The Pyramid prophecy is very definite—this is an age for transformed man. Mental wish-bones are not enough. Your fitness to earn a living twenty years ago does NOT fit you to earn a living today.⁹ And spiritually, you have no right to share the wealth and joys of those who go forward, if you are still looking backward—thinking of what you used to have, and how well you used to do your work.

As a plant must grow anew each season, so you must grow anew, to accord with the divine change being wrought in this age. Doors of the past have been closing to many who grow older instead of younger. Are you one of them? If so, begin transforming yourself today. Do not be a machine any longer—slowly running down! Transform each action each day, until you become a living soul—increasingly youthful in activity!

All material wealth will henceforth depend on mutual service, one to another. Fit yourself to enter this new age. Fit yourself to be a *leader* in a world of action leaders. Then a thousand emerald gates to golden opportunity shall open to you!

LEADERSHIP

In the Hall of Transforming Action, when all wealth will be created by service, *leadership* will be in demand. NOT leadership by talk—millions are talking now, and out of jobs. The new kind of leadership in demand is action leadership. In it there are scores of opportunities—not waiting behind locked doors, but with doors flung wide open—*begging you to enter in, to take possession of the treasures of this new life!* “There are only three¹⁰ fields of work: (a) making, handling and creating *things*; (b) using *words*; and (c) leading and directing *people*.” This illumines the need of today and the opportunity.

⁹ *What to Do in These Years—Four-Fold Plan of Action*, by Brown Landone.

¹⁰ *The Success Process*, by Brown Landone, p. 203.

Men of all ages have become great only as their thoughts and ideals were transformed into action. In this new age, we are attaining not only action, but leadership in action! The great need this hour is the need of real action leaders.¹¹ For years, there has been so much talk, that the need of action leaders is greater than at any previous time in history. The world is crying for action. Every group of human society—from the smallest church and welfare group, to the most titanic business organization and government—is begging for men who 'can get things done.'

There are now very few action leaders. Yet in our country alone, there is need of eighteen million action leaders—and need of them at once. We need one for every seven people—from kindergarten to the highest official in every organization. We need this great number to restore action-power to our democracy. Here is a work for you. Those who fit themselves to meet this need will find opportunity begging them, to accept real compensation and render great service to mankind.

THE WEALTH OF SERVICE

When man transforms society on the basis of service one to another—man's wealth and compensation will be a hundred-fold greater than ever in the past. This change of human society from dependence on wealth of things to creation of wealth from service is the great transforming economic advance of many thousand years. In the transformed human society of the years 1939 to 1947 there will be limitless opportunity for everyone, because there is no limit to the desires of man—either to render service, or to receive the benefits of service rendered.

Organized action leadership to advance the use of new ultra comforts will begin the restoration of action-power to man. Then its spread in remedying the ills of industry, in all business, in initiating world peace and empowering democracy again, will provide service for all. This attainment of transformed life will not come in a second, but all the conditions of such life will be initiated before 1947.

I have written little of this Hall's symbols and dates, because I have given space to what they reveal, for that is so much more important to us now. Let me, however, take space for but two more of its 47 symbol groups, so that you may see how truly the mystic men of old foretold conditions of these years.

¹¹ *Training in Action Leadership*, by Brown Landone, L-I.

There is one group of number symbols of *speed-up* movement in *air*, resolving into almost *zero space-time*. Is this coming true today? Certainly the speed of movement in air—the airplane—is cutting down space-time to almost zero. Then in another group, there are symbols of *man-effort disappearing*, with a *speed-up* movement which multiplies and *remultiplies forms*. It is amazing that the mystics of old, without knowing how we would express such a condition in our language of today, could prophesy that man-work is disappearing with the speed-up of new machines which multiply and remultiply things.

In the higher transformation, true spirituality will be actually attained. This will be a new goal never before attained except by the initiated few, because in the past, man's ideal of spirituality has been a misconception and his effort to attain it has been twisted. We have thought of spirituality as a concept of idealism. But in truth, spirituality is a *result*. When spirit expresses through man, then the result is spirituality. And so spirit never becomes spirituality until it is expressed. Then also our effort to attain spirituality has been twisted. Man does not become spiritual because of what he does NOT do. Man becomes spiritual by the degree of spirit he brings into expression. Spirituality increases with the more complete and ever-expanding radiation of man's soul into transforming action.

OURANOS ON EARTH

The truth of the prophecies is proven; fulfillment rests with you. *All now depends on your transformation of yourself to fit in with the changes of these years. Do not wait even one hour longer!* By March 6, 1947, the world will have effected changes so great that all conditions in which man has been living will be transformed. Then on March 7 of 1947 man will leave this Hall of Transforming Action, and enter the Temple in which all things are made new!

Repent and be saved—that is, *turn completely around in the other direction*, for that is the meaning of the Greek word which is translated repent. So turn around completely, away from your old fixed life. Turn toward the transformed life!

And seek ye the kingdom of heaven on earth! Stop shrinking up! The word 'ouranos' is translated *heaven* in the New Testament. Jesus tried to make it clear. He said that heaven is like unto a mustard seed—one mustard seed will produce a whole

field of plants. And Jesus said, heaven is like unto leaven, and leaven is *yeast*, and it spreads and expands and keeps on expanding.

Ouranos means infinitely increasing and expanding activity. That is what Christ meant by heaven. And the kingdom of heaven is within you—the power of ever expanding into new youthfulness, into action instead of talk, into leadership in action, into activity like unto spirit. Then the earth of this new age shall be heaven unto you.

“Be ye transformed!”

XXX

SEVEN TEMPLES OF SEVEN CIVILIZATIONS

Great civilizations—as I use the term—are long waves of civilization; and the culture of a Babylon or Ur or ancient Guatemala is not a civilization by itself. Yet all are similar in mode of development. In each civilization wave, mystic wise men of Melchizedek used data of mathematics and astronomy—based on movements of earth and stars, which are forever the same! They also used Teleois proportions, which are eternally the same! These measurements and proportions they built into each *key* temple of each great civilization, including the Great Pyramid.

TEMPLE OF GOD-IN-GOLD

The key temple of the most astounding civilization on earth was built on the high *eastern* side of the Andes. This civilization and its subsequent cultures surpassed anything that has followed. Of the Tiajurans archeologists know very little, and of the pre-Tiahuanacans, they know but little more. No other civilization has developed on lands so high, or reached such heights of power, social justice, and spiritual idealism. On the one hand, they built titanic structures of the most *gigantic* stones every used; on the other, they made the *tiniest* and most exquisite things found on earth. In one of our museums there is a tiny, seven-sided piece of their fine gold work—no larger than a pinhead—each side beautifully engraved, so finely done you cannot see it with the naked eye. Of their science, there is evidence of skillful abdominal operations, bridge work and filling and crowning in dentistry, et cetera. To meet human needs, they developed governmental, educational and economic systems so just that poverty was impossible, and the greatest individual wealth ever known.

Their key temple was lined on the inside and covered on the outside with great sheets of pure gold! The holy plaza around it was set apart by gigantic chains of solid gold; altars were of gold. In the inner temple garden, there were trees of carved gold! Once these records seemed unbelievable; but archeological find-

ings now indicate they are true. Just one¹ example—three years ago—a large gold breastplate and crown were found—both of pure gold; *the crown was two feet high—solid gold!* All holy things were of gold—even the plow the high priest used in his farming—because gold was the holy symbol of the radiancy of God, incarnated on earth.

TEMPLE TO THE STARS

Second, there is the key temple of the Mayan civilization, whose structures we have been lately unearthing and restoring. The astronomical knowledge known to their mystics is so amazing, it makes us gasp today. The proportions of the holy room of the structure of the Great Temple of the Sun-in-Gold (or God-in-Gold) of the pre-Tiahuanacan civilizations are repeated in the amazing Caracol of the Mayans. Then both of them are symbolized in the Great Pyramid. But everything built into the Pyramid was known in the Andes long ages before the Pyramid was built.

CATHAY—ELEUSIS—JERU-SALEM

Third, the key temple and other sacred structures of ancient CATHAY—the pre-Cathayan Temple of Heaven, preceding the oldest Chinese cultures of which historians write—also embody all that is built into the Pyramid.

Fourth, proportions of the structure and even of minor parts of the Temple of ELEUSIS—Temple of the worship of life, when still a highly spiritual worship—repeat the designs in the Great Pyramid; and these are found also in the Temenos, sacred area of Ur, so long ago that Ur² was then an island out in the Persian Gulf!

Fifth, the design and proportions of the HOLY of HOLIES in the Temple of Jerusalem—including dimensions of the Sacred Ark—are recorded in the Great Pyramid.

The two other temples of the seven key temples are, first, the Great Pyramid—the Temple of Conforming Power; and second, the New Temple in the eastern Andes.

The first three temples mentioned above were built, respectively, 4497 years, 3031 years and 761 years *before* the Great Pyra-

¹ *New Roads to Riches*, by Edward Tomlinson, p. 265.

² *Ur of the Chaldees*, by C. Leonard Wooley, p. 17.

mid, the fourth and fifth, 1331 and 1869 years, respectively, *after* the Pyramid was built; the mid-year of the Pyramid was 2881 B.C., and the New Andean Temple is now being built.

The Thibetan development is very recent; it is an offshoot of ancient Cathayan culture; and the *time* when the temples of Thibet were built may surprise you, because you have probably been given the impression that they are very old. All temples of all Thibet are very recent! I do not hold that the mystics who directed the civilization of ancient Tiajura were the same men who, thousands of years later, designed the Great Pyramid, and then still thousands of years later established mysticism in Thibet. But it must have been the same Order or Brotherhood, which left the records of the design of the Pyramid—*not* in Egypt, but in Temples built 3679 years afterwards, thousands of miles distant, in the sacred city of Lhassa in Thibet.

The evidences are many. In the Great Hall of Initiation in Lhassa, one sees the same sacred boss which was built into the Great Pyramid, 3679 years before! In the House of the Master in Lhassa, we find symbolized another Holy of Holies. In the Temple of Rammoche and in the sacred Thibetan monasteries of Drepung and Sera and Ganden, we find symbols and exact proportions of structures found in Tiahuanaco and Mayaland, and in the Temples of Eleusis and in the Great Pyramid of Gizeh. All of these must have been built by the same *continuing* order of mystic wise men!

TO GUIDE US

The knowledge of the wise men is recorded; their prophecies are cut in stone; they have come true, and are being fulfilled today. It gives us a divine certainty, a something which gives sublime faith, to know that those—who built their knowledge and prophecies into the very structure of all key temples—knew what they knew! Since they symbolized in the stone of the Pyramid the great attainments of civilizations existing thousands of years *before* the Pyramid was built, there is proof that their knowledge of the *past* was certain. Since they left in the Pyramid records of symbols to be built in the Holy of Holies, and the exact date when it would be built, 1869 years *after* the Pyramid, there is proof of the truth of their prophecies of the *future*. Both knowledge and prophecy are evidence that these mystic wise men knew the rate of man's progress of the past and the future, and

that they have given us something on which we can depend.

Such certainty of truth gives us undoubting faith! If these mystic wise men knew the past before it was past, and know the future before it is the future—their guidance for us can be more certain than anything human on earth today. In this age of transforming change, there is need of guidance. Millions of souls know not what to plan or do, or what the future holds. There is doubt of the past, confusion at present, uncertainty of the future. To some the uncertainties are so great, that it seems useless to continue desiring that which they have so long desired without fulfillment.

In the midst of such conditions, there comes to YOU—my reader—both a call to service, and a great spiritual and practical opportunity. Read again the section on leadership in Chapter XXIX. Then read Appendix NINE—*Action Leadership*. Then for your own development and preparation, and also for the inspiration of others, form a little group of seven members which you shall inspire, lead, and direct. Share this book with them. Consecrate each meeting of your group, to the guidance of each member, and to your own increasing fitness in leadership. Take up with your group the seven steps of progress—found in each Chapter of the *Meanings* of the temples. This is a spiritual call to you, and an opportunity. The need is very great. In fifty years, man has been whirled into new conditions, by rapid changes wrought by science and machines, by amazing changes in modes of life, by changes in government and concepts of philosophy and religion—all reforming in new forms as differently as those of changing pieces of glass in a kaleidoscope. Others are confused; they need your help; do not fail them.

Because of these whirls of change today, the faith of man in the past forms of divine guidance is lessened. And man is stranded, for he has not yet attained faith in any new form of guidance for the present or the future. Man needs a new realization that the Divinity of old, is THE Divinity of today.

The greatest boon YOU can bring to man today is certainty. Certainty depends on faith in a divinity that is Creator of ALL of creation—omnipresent in all creation. To this end, I here give you my concept of God in all things, so that you shall never again feel apart from God:

“The *Power* that twirls a mist to star and grinds a sun to star dust, I term God. The *Energy* that shoots through all quintillions years of space, I term God. The *Great Activity* that moves

the sea and turns a billion suns; the *Mind* that has called forth a Betelgeuse and now creates electrons; the *Love* that makes true brothers of the stars and stores up sweets for bees; the *Life* that urges man to produce man, fern to produce fern, and atom, atom; the *Joy* of stars eternally on wings of flight, of birds at dawn, of running waters, singing leaves, of all the laughter and the mirth and cheer and dancing merriment of earth, the joy of knowing God is God, and Life is Life and Joy is Joy—I term, God.”³

Man *wants* sure faith in such divinity, and man *needs* faith in that which knows and e'er reveals the help he needs—a something, born so certain it can span the thousand eras of the past, and present too, and knows the future as it knows the past. Something that knows the very nature of the progress of man's life on earth, and when the changes in his future will take place. God gave us law; then sent the Son to save all life, by love; the Holy Spirit to uplift and transform all; and now reveals Melchi-Zedek—the King of Power and King of Peace on Earth—eternally, like to the Son, to be a guide to us, today, tomorrow and forever. We now have something certain and sublime, on which we can depend. The prophets of the past are seers; they are the wise men of today—ordained to guide aright, to bring to us the power and peace of Melchi-Zedek, the Tia-Tiaua-Tia of Melchi-Salem!

³ *My All-God*, by Brown Landone, closing chapter of *My Idea of God*, edited by Joseph Fort Newton.

Read

XXXI

A HOLY DAY FOR YOU

Date—Your Birthday

For you there now are possibilities, new born—and greater far than those you oft have dreamed in dreams! And they can now become realities, for after many ages there is now a union of the mystic wisdom of the past with all that science knows today. These two have now been wed, and made as one! Their holy union is a birthday unto you—a day of life new born.

This birthday is the advent of a year of new transforming change! *A change for you THIS year!* And so, begin the transformation now—from loneliness, to happiness; from lack, to plenty limitless; from being out of line, to fitness for the new! And be transformed from growing old, to renewed youthfulness; from unresponsiveness, to full response unto all energy and power; from living in the caves of life, to living with the stars.

It is a birthday new, *for you!* Waste not one hour; begin the new life now; seek guidance alway of the King of Peace and King of Power; and be reborn—not once, but every dawn, and each high noon, and every starlit night.

Six cultures of the past have come and gone. Each rose to dazzling heights and disappeared. The reason why each died is that each people wrought the greater change in the things outside themselves, and failed to make like changes deep within. Until the year of 1939, we too have done the same.

We have created miracles in things and processes. But man has wrought no great transforming change within himself for seven thousand years! Our hands are not as skillful as the hands of early Tiahuanacans, and through the long, long ages since their time, we have not equalled them in skill. Our bodies now are not so perfect as the bodies of the ancient Greeks. We have produced no mathematics new, which equal what the Moors and old Egyptian priests worked out before our time. We have no clear philosophers like those of India and Greece and old Cathay; no prophets and no seers like those of ancient Palestine! And more—no nation on this earth has even tried to live the teachings of

redeeming love and brotherhood of man, that came from Him who taught by Galilee!

All great advances we have made, have been in *things* outside ourselves. Our failure is the lack of change *within* ourselves.

And yet, we shall not go the way of other cultures of the past. New means are given us; and science now proclaims—first time in history—that man now has the means by which he can *transform* himself—new means that transform consciousness; transform the body too; and all the million things surrounding man and used by man. To use these means we must uplift ourselves, transform ourselves, so that we shall have power to *use* the things which we ourselves create and have created in the past.

Two paths are open now to you: the one leads upward to the stars; the other back, and downward too, unto the caves of struggle and of strife. You must this hour, now make your choice. Shall you henceforth continue, slowly dying till you reach the end, or will you be reborn, and live again the youthfulness of life?

TO LIVE, OR —?

So choose to live, or choose to die! You now have means by which you *can* transform yourself. And if you choose to live, to truly live—you shall have power to work a transformation which will make the dreams of long, long ages now come true!

Six times on earth—as I have said—great cultures wrought by man have come and gone! Each disappeared because its people did not change themselves enough to gain control of things which they created in their day.

And we today have failed to change ourselves. We have invented means to talk five thousand miles by wire; but can not talk one hour without so boring other men, they wish that we were dumb. We have the means of hearing music from across the sea; but many million souls are so afraid, they have forgotten how to sing. Our gases and explosive chemicals can slaughter man by millions every year; but we have not as yet transformed ourselves so that we can prevent such use, and always use what we create for benefit of man.

WHY ARE YOU HERE?

There is another reason for all this. We still are **BOUND** by old philosophies, which twist the truth and blind us to the pur-

pose of man's life on earth. *For ages, those philosophies have taught that man is here on earth to STRUGGLE to attain enough to try to live.*

This is the most amazing, senseless and enslaving diabolic thought e'er taught to man!

It is a vicious sin to teach that man is here on earth to work himself almost to death, in order to exist until he dies!

Man was not given life, to struggle and to strive—for even in creation God gave man the right to rule and have dominion o'er all things of earth.

To live, enjoying life—that is the one and only purpose of man's life on earth. All other stated aims are twisted hind end to, and are malevolent and sinister!

The apples grow upon the boughs of trees, and fall with ease into your hands. But you are always taught to wallow, with your face deep down in mud, and struggle long to find the apples there!

To live and enjoy life is the one end of man! Once recognize this truth, and all of life will be transformed for you. Christ¹ made this clear: he taught that he is LIFE, and that he came to earth so that his JOY shall be fulfilled in us! This is man's primal purpose here on earth. All else are trivialities!

Man wants but seven things.

The first, is free *activity*—man wants to run and jump and bat and throw a ball and dance and swim and dive and ride and drive and fly. Think long of those—they all are free, and they include ALL actions which give joy to all the sport and play on earth.

Then second, man desires to *eat*.

And third, to *laugh and sing*—this is another primal purpose of man's life!

Then fourth, man wants a happy, free *association* with his fellow man.

And fifth, he wants enjoyment of the fulness of all *love*.

Then sixth, he wants *expansion* into ever new activities, and thoughts, and high ideals.

¹“As in the past, so Christ today would teach us joy. And what would shock our sour worship most, would be his teachings of the joyful service which he knew; and how the happy David, chosen one of God, both sang and danced in worship when they brought the Holy Ark into Jerusalem.”—*The Christ Men Can Follow*, by Brown Landone, p. 183, in *Best Sermons of the Year—Book IV*.

And lastly seventh, man longs to *worship* that which is forever greater than himself.

These are the only primal aims and much desired activities of man on earth! They fill his life with joy. Naught else e'er matters much.

And all these seven things man wants are free to him! They can be had without an hour of struggle or of strain. And if you doubt that they are free, then realize that you can laugh and sing and run and swim and love and worship—free. So if there is but one of all the seven things man wants that is not free, it is the food man eats. So let us study that.

The earth abundantly produces all man wants, and science now can multiply the growth a hundred-fold.

And so you do not pay for *food*; instead you pay to keep four struggling efforts ever going on. One group of men are struggling to maintain a price so high that it prevents you from obtaining food, until you struggle too, to earn enough to pay that price. And farmers struggle just to get enough returns to pay for struggles of another group of men, who strive to hold up prices of the things the farmer needs in raising crops.

Remember, water, earth and sun produce all things you want to eat; there is no money cost, for they themselves ne'er ask for taxes, interest or wage. The sun shines free; and rain is free. *All hindering costs are due to struggles man creates to keep on struggling*, for the things he wants and could so easily attain without the strife.

Our economic system is the strangest thing e'er known on earth. If our economists possessed the wisdom squirrels have, all life for man would be transformed o'er all the earth, within a year.

If we continue as we have been doing in the past, we shall create great frankensteins of war to kill off half the men of earth, and then by our strange economic plenty, starve the rest.

That these—the seven purposes of life—are primal here on earth—is proven by results. With just a little freedom of activity—and laughter too, and song—all ills of body and all burdens of the soul will vanish into nothingness! Why, then, do you forever struggle through the day and half the night to earn enough to pay some other person for the things which never can compare with that which you want most?

Once glimpse the great significance of this, and all of life will be transformed for you.

The spirit of the King of Peace and Power is now enfolding you and speaking unto you: *This is a birthday new for you, reborn to youthfulness and joy!* I give it unto you each hour—at early dawn, high noon, or starlit night, or when the moon shines clear, or clouds are softly veiling stars, or when it rains, or mists are hanging jewels on the trees—each hour is e'er a birthday new for you.

A birthday of rebirth—record this birthday now as you are reading this, *for it shall henceforth be the hour of your rebirth—unto all things your soul has long desired.* You are reborn so that your dreams shall now become realities to you; reborn to free activity, to run and dance and swim and fly; reborn to laughter and to song; to happy free companionship, to fulness of all love, to e'er expand in action and ideals, and e'er to worship and adore all spirit higher than yourself, and thus be guided with the certainty of stars in heaven.

This birthday glorious, which I am giving unto you, will reach its fulness and its joy as you shall share it too—this very day—with other souls, to give new birth of life to them.

If you but change, accept rebirth and pass the birthday on, then others too shall be transformed, and soon we shall attain complete fulfillment of the prophecy—"It shall be done on earth as it is done in heaven."

So be ye now transformed.

"The first heaven and the first earth are passed away."

The sacred seer has seen "a new heaven and a new earth . . . descending out of heaven . . . and having the glory of God!

"The city lieth four-square . . . pure gold . . . and has no need of the sun, neither of the moon . . . for the glory of God doth lighten it!

"The gates of it shall not be shut at all by day; and there shall be no night there."

APPENDIX ONE

ANTIQUITY AND CULTURE OF TIAHUANACANS AND MAYAS

Early exact dates of ancient Andean civilizations are not known, and of the cultures even of their latest decadent followers, "our various informants¹ differ from one another in regard to every detail." It is certain, however, that the ancient Tiajurans and pre-Tiahuanaco people were highly civilized, long ages *before* the dates usually given by historians.

Not to confuse you by many terms, I use Tiajuran and pre-Tiahuanacan to mean perhaps *four* civilizations preceding the Tiahuanacans. Building ruins of the later Chimu and Nazca cultures are but poor imitations of much earlier structures of the Tiajurans. The Incas of Peru were not even a people. Inca means king or war lord. Each ruled only a section of the very decadent remnants of what had previously been great cultural empires. I use Maya very generally, to designate all later civilizations farther north—in Central America and Yucatán in Mexico.

There are several reasons why historians have made mistakes about early dates. NO recorded dates of Andean peoples have been found. And historians have accepted dates found in manuscripts of Spanish priests in Peru after 1535, based on hearsay tales obtained from peoples who remembered only legends of the preceding civilizations. "*The most bewildering lot of information and misinformation² that the historian ever tackled.*" The dates of these manuscripts are about as reliable as the 'dates' which an Irishman, born and always living in Texas, might give of ancient Celtic culture in Ireland. Moreover, every Spanish priest of that time could not even think of a date earlier than 4100 B.C., because they then believed that earth was not even created at that date.

Another factor of error is the earlier mistaken idea that these cultures had moved south from Mexico and Central America. All recent archeological evidence indicates that the earliest civiliza-

¹ *Fall of the Inca Empire*, by Philip Ainsworth Means.

² *Ancient Andean Life*, by Edgar Lee Hewett, p. 140.

tion of which we know, developed on the *eastern* slopes of the Andes; that thousands of years later it moved *westward* over the mountains, and then still later slowly *northward* to regions now known as Guatemala and Yucatán.

Much evidence proves the great antiquity of the pre-Tiahuanacans.

FIRST, there is the evidence of the time-rate of dust accumulation and its formation into earth, sufficiently thick to cover and hide cities of the past. No other civilization was ever built on mountain lands so high, and in these mountain regions, winds blow dust *away* to the lower levels. Therefore, dust accumulation over ruins in these high regions indicates exceptionally long time-periods. The rate of accumulation has been carefully calculated by geologists. Many ruins are covered with several feet of new formed earth—not in a few places only, but in widely spread sections in areas of thousands of square miles. It must have taken several *thousand years* to form such dust-earth.

SECOND, over the mountains in the western lower regions of Peru, the cultures developed much later. And here archeologists have found five strata of cities of different cultures, one on top of the other. It takes time for the massive buildings of one civilization to disappear and be forgotten, before another era builds upon its ruins. Each of these must have lasted hundreds of years with other hundreds of years elapsing between one culture and the next.

THIRD, there is evidence of great antiquity in the number and workmanship of *tooled* stones found. Anywhere in a million square miles one can find gigantic stones, "of almost inconceivable ³ age," perfectly tooled. These peoples used no mortar, so each great stone was tooled with mathematical exactness, with many sides of different slant, so that when put in place, it fitted perfectly with other stones, irregular slantingly sided tooled stones. It must have taken millions of workers thousands of years to tool those stones.

FOURTH, there is evidence of the number of graves and mummies. With their highly socialized civilization, hygiene and elevation made for health. The death rate could not have been excessively great. There are millions of graves and "hundreds of millions ⁴ of mummies." These people did not die of epidemics,

³ *Old Civilization of the New World*, by A. Hyatt Verrill, p. 56.

⁴ *Ibid.*, p. 246.

for caskets are often gold lined and contain art objects treasured by the person buried. Age upon age must have passed before so many millions could have died.

FIFTH, there is the evidence of the *time-growth* of other American civilizations, of the *Mayas*, for example. A people must evolve for several thousand years before they develop a science of astronomy that discovers that, on May 16 and July 26 of each year, the line of sight to a star 335,000,000,000 miles away is exactly the same as the line of sight to the sun only 92 million miles away; and architectural science which made it possible for them to orientate buildings, so that they faced directly west⁵ on these two same days—particularly since direct west to the setting sun is different for every location on the face of the earth, and differs for every day of the year. Such knowledge does not evolve in a few hundred years. And the pre-Tiahuanacans were a much earlier people than the Mayas.

SIXTH, there is great probability of historians making mistakes in judging the antiquity of one people who have left no calendar records, when they try to guess its chronology from date records of some *other* civilization.

The Mayas did have a dated calendar. Very remarkable work has been done in decoding it. But no one knows the base date with which to begin. And it is quite another thing to try to judge the antiquity of the Tiahuanacans by the uncertain dates of the Mayas, whose civilization developed ages later, and thousands of miles away.

SEVENTH, there is possibility of error in interpreting numerical systems which differ from our own. Consider, for example, the Maya system. In our system of numbers, the position of '6' in 60, means that 6 is 6 times 10. But in the Maya system, the same 6 in 60 is 6 x 2 x 10. That is, to us 60 means 60. But to the Mayas, 60 meant 120.

And figures used in calendar reckoning were otherwise modified. When we write 265 days, it means 265 days. But by the Maya system, the same 265 means 2 x 20 x 20 days, plus 6 x 20 days plus 5 days. That is, when we see 265 days⁶ in a Maya inscription, it means 925 days.

Then also, to us a number of days expressed by the series 14, 19, 8, 0—as usually written by archeologists—would mean the sum total of those figures, that is, 41 days. But to the Mayas, this

⁵ *The Advance of Science*, by Watson Davis, p. 320.

⁶ *Old Civilization of the New World*, by A. Hyatt Verrill, p. 111.

same series meant 1,403,800 days.⁷ When historians use a peculiar calendar scheme of *one* people to determine the unrecorded dates of *another*, conclusions may be very mistaken.

EIGHTH, there is the evidence of the ages necessary for any civilization to evolve. A civilization does not attain a great height of development in a few hundred years. OUR OWN civilization is the result of all the civilizations of western Europe, and of some of those in northern Africa and southern Asia. We go back to Rome for our law; to Greece for art and architecture and philosophy; to Egypt and Palestine and southern Asia for our religion; perhaps further back for our knowledge of mathematics, which has come from some far, far past, by way of ancient Egypt and Phoenicia and the more recent Arabians. Hence, our civilization of today goes back to cities of such culture that they were called "cities of books" 5950 years ago; to extensive⁸ City Planning, 7500 years ago; to the keyed arches and slender pillars developed 9900 years ago; to tiled sewerage systems 10,200 years ago; and to the hip-roof of 12,950 years ago!

It is ridiculous for historians to assert the early pre-Tiahuanacan civilizations and their succeeding cultures—which surpassed ours in many ways—reached their great heights of attainment, by evolving out of savagery and sinking into nothingness—all in a few hundred years. They must have been developing 12,000 to 14,000 years *before* reaching the heights they attained several thousand years ago.

NINTH, there is the evidence of all recent reliable geologic, archeologic and paleontologic discoveries. Each of these sciences is pushing its respective dates back to ever earlier dates. Civilizations in southern Asia, which we once dated 4000 and 5000 years ago, we now know existed in high states of culture 8000 to 10,000 years ago. And it is known that the Early Stone Age⁹ goes back 500,000 years. And science now accepts Moir's conclusion that the highly developed polished stone work¹⁰ of man goes back to at least 1,000,000 years ago.

Even in North America—most recent of all—sculptured stone heads and faces of man have been excavated, which—after a careful ten-year study—archeologists and geologists agree must be more than 25,000 years old! And human skeleton parts have been

⁷ *Ibid.*, p. 112.

⁸ *The New Science and the Old Religions*, by Thornwall Jacobs, p. 354.

⁹ *The Conquest of Civilization*, by James Henry Breasted, p. 10.

¹⁰ *The Advance of Science*, by Watson Davis, p. 341.

found *underneath* skeletal parts of *extinct* species of camel, elephants and mastodons. It is many long ages since those animals ran wild over Arizona and Texas. There is now unquestionable evidence that "there *were* men in the New World¹¹ in the days of the mammoth."

Since men lived in North America and sculptured stone faces 25,000 years ago, why do historians assert that the cultures of the Andes began only 2100 years ago! The ancient Tiajurans had reached the peak of their civilization a thousand years before the Tiahuanacans began to form their culture; the height of Tiahuanacan civilization was attained long, long afterwards; and it had already been followed by a second Andean civilization, which in turn had declined and then been followed by the Incas, who had begun their decline before the Spaniards discovered them after 1500 A.D.

Since the civilization of the ancient people of the *eastern* Andes and their succeeding cultures, surpassed in nineteen different ways the highest cultures of Egypt and Cathay and Greece, and all civilization of modern time, it must have taken thousands of years—instead of a few hundred—for these people to reach the heights attained.

¹¹ *Ibid.*, p. 317.

APPENDIX TWO

THE MYSTERIOUS DISAPPEARANCE OF KHUFU AND THE UNFINISHED PYRAMID

There is a mystery about the unfinished condition of the Great Pyramid. The original design was not followed after 2879 B.C. Even the changed structure was not finished. Then also, due to slight sinking of rock underneath it, the Pyramid began to settle before it was finished; and perhaps an earth tremor also helped to cause the cracks and fissures in the lower part.

Why was the original design abandoned? In ancient Egypt each tomb and pyramid built to the glory of a reigning king or pharaoh was *built by himself* during his reign.

Khufu the Great died in the year 2877 B.C. From historical evidence we know he was ill for two years before his death. Of his death there is much mystery. A year before he died, a magnificent funeral temple was hurriedly built by Khufu on the eastern platform which was a real part of the Great Pyramid, extending all the way around it. In this mortuary temple, sacred and awe-inspiring and gorgeous services were held when Khufu was reported to have died.

There is also the question of what became of the mummy of Khufu. Other great pyramids of this group are proved to have been burial places for the actual bodies of other members of the Khufu dynasty. A mummy was left in the mortuary temple of Khufu, but it now appears that it was not the body of Khufu the Great. Khufu seems to have disappeared.

There is evidence of a long hidden and at present still undiscovered passage from this mortuary temple, at the east base of the Pyramid, running underground and up into the Pyramid. But no tomb chamber in the eastern half of the Pyramid has yet been opened. The very peculiar fact of our present knowledge of the Great Pyramid is that all chambers which have now been opened are in the *western* part. And although the mortuary temple was built outside at the base of the *eastern* side, nothing is yet known of what may be found within the Great Pyramid east of its center.

Whatever the cause, the Great Pyramid was never finished as it was designed. The great Altar-Ark of the Holies of the Living Dead was not even properly put in place. No altar cover was made to complete the altar. The inner temple design on the west wall of the Temple of the Mystics was not finished. The secret granite door—designed for the entrance to the Passage to the Temple of the Mystics—was never even brought into the Pyramid. The floor section at the beginning of the Great Hall of Progress—removed to open a way downward, to locate the fissures near the base of the Pyramid—was not repaired.

The present condition of the Pyramid is shown by the irregularity of the floor blocks from the Hall of Progress to the Temple of Transfiguration, as pictured here in *Figure 13*. The floor of the Temple of the Mystics has settled more than 13 inches. There are eight great fissures near the base of the Pyramid. The irregu-

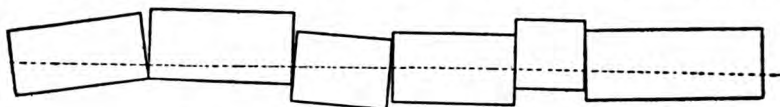

lar passages—cut from the Descending Passage to the pit, and then up to the workshop—are evidences that the settling took place before the Pyramid was finished. It had settled so much that—to take in the finishing marbles for the Temple of Godhood—the workers were forced to make a passage from the upper part of the Great Hall of Progress to the superstructure of the Temple of Transfiguration.

Something else prevented the Pyramid from being finished as designed. Whoever directed the work after 2879 B.C. seems to have lost interest. Up to a certain level, the great stones are fitted together with the delicate accuracy of the work of an optician. The joinings are less than 1/10,000 of an inch, and the cement so fine and binding that it is superior to any cement our modern chemists make today. But in the upper part of the Pyramid, the work is often crude. After the as yet unopened Temple of Godhood was finished—with rose tinted and black granite and polished gleaming white limestone, and its entrance sealed—no other work of high quality was done.

The original plan had been lost or mysteriously taken away. The Pyramid was designed to the height of a sacred *triple cross*, which was to determine all major heights within the Pyramid. But the workers who tried to complete the structure seem to

have known little of this original design. Without directions, it seems that they tried to build the outside top to a peak like the tops of other Pyramids. Since they somehow discovered that they had built the top too high to accord with the triple cross design, they merely stopped, left a flat top, and failed to add the "caps of the years" and the "spheres of the days" which had been designed to symbolize the solar, sidereal and anomalistic years.

Another mystery about Khufu is the records in the Temples in Thibet—not only in the Holy Temples at Lhasa but in the Monasteries at Drepung and Sera. There are records of Khufu's having been a great and holy man of India, ten years after his death and burial in Egypt.

Was the original design abandoned and the Pyramid left unfinished, because Khufu attained such a height of spiritual consciousness that a monument dedicated to himself no longer had any personal appeal? Was it enough that the mystic wise men—who had designed the temple with him—had already embodied in its very structure the secrets of the ages and the forecast of the future?

APPENDIX THREE

SOLAR DATA IN PYRAMID

I hope here to give a few simple and understandable statements. They clearly indicate amazing knowledge of mathematics and astronomy. This knowledge was possessed by the designers of the Great Pyramid. The facts relate to the number of days of our solar years and the number of years of the precession of equinoxes.

Our solar year is the number of *days* it takes our earth to circle around the sun. The precession of equinoxes is the number of *years* it takes our solar system to whirl around the center of our great universe of stars.

Modern astronomy has, after many decades of exacting measurements and mathematical calculation, determined:

- (1) That the length of our solar year is 365.2422 days.
- (2) That the length of the precession of equinoxes is 25,827.5 years.

Now consider what the mystic wise men, who designed the Great Pyramid, knew of these facts.

FIRST, the total distance around the base of the Pyramid is 36,524.22 Pyramid inches. This is exactly 100 times 365.2422—the number of days of our solar year.

SECOND, the length of each side of the Pyramid at its base is 9131.05 Pyramid inches. There are 25 Pyramid inches in one Pyramid *cubit*. Divide 9131.05 by 25. The answer is 365.242 cubits. This is the length of each side in cubits. This number is also the same as the number of days in our solar year.

THIRD, the height of the designed Pyramid is 5813.02 inches. When you went to school you learned how you could determine the circumference of a circle, IF you knew its radius. The rule is: multiply the radius by 2, and then multiply that result by 3.14159.

Let the height of the Pyramid—5813.02 inches—represent the radius of a circle. Multiply it by 2; then multiply that result by 3.14159. The final answer is 36,524.2. This number is 100 times the number of days of our solar year.

FOURTH, in the *Temple of the Mystics*, the height of each of its two supporting side walls is 182.6211 Pyramid inches. The combined height of the two walls is twice 182.6211 inches, or 365.2422 inches. Again we have the exact number of days of our solar year.

FIFTH, from the *Hall of Unity* to the *Hall of Transforming Action*, the floor length is exactly 116.26 inches. This is the diameter of a circle of which the circumference is 365.242 inches—the same number as the number of days in our solar year.

SIXTH, the floor length of the *Temple of Revelation* and *Hall of Adjustment* is 36.5242 inches—one-tenth of the number of days of our solar year.

SEVENTH, the floor length of the *Temple of Transfiguration* is 412.132 inches. This is a designation of relation to areas. The area of a circle whose diameter is 412.132" is the same as the area of a square each side of which is 365.242".

EIGHTH, the combined length of the two diagonals of the base of the Pyramid is 25,827.5 inches. That is the exact number of years of the precession of equinoxes.

NINTH, distance around the Pyramid at the level of its 20th course of stones—the level of all floors of the upper halls and temples—is 25,827.5 inches. Again the same number as the number of years of the precession of equinoxes.

TENTH, the height of the Pyramid, from the floor level at its 50th course, to the designed top, is 4110.57 inches. Remember again the rule you learned in school. To obtain the length of the circumference of a circle, multiply the radius by 2, and then multiply the result by 3.14159.

Use 4110.57 as radius; multiply it by 2; then by 3.14159. The result is 25,827.5—the number of years of the precession of the equinoxes.

ELEVENTH, in the Pyramid the exact distance from north to south walls of the middle chambers of the upper level is 116.16 inches. The height of wainscot of the west wall is 103.033 inches. The area of a square, each of whose sides is 103.033, is equal to the area of a circle whose diameter is 116.16. And the circumference of such a circle is 365.2422, again the number of days of our solar year.

TWELFTH, from the length of the side of such square (side 103.033), these mystic wise men formulated systems of measures of quantity, time, weight; and lengths and squares and cubes of the lengths. Since all of these are based on the length of the side

of the square, and since that length was derived from the circle whose circumference was equal to the days of the solar year, and since the time of revolution of earth around the sun is eternal, *these mystics created the only system of measurement forever exact, and eternally the same.*

THIRTEENTH, perhaps most amazing of all, is the beautiful design of a modernistic skyscraper cathedral tower on the west wall of the Temple of the Mystics. Its height in proportion to the height of the supporting side walls of the Temple, makes it possible to determine that strange number—3.14159—which in mathematics we call Pi.

Many other and even more amazing facts of mathematical proportions and astronomical distances are worked into the structure of the Pyramid.

APPENDIX FOUR

DAVIDSON'S DATES

Many people have faith in the prophesied dates of Davidson, because in one instance—in what he calls the War Passage—he is nearly correct in time periods and prophesied dates of the First World War.

To understand why these few dates are almost correct, while Davidson's other dates are mistaken, please recall the arithmetical fact that when you multiply one by one, the answer is only one. Even if you re-multiply one by one, forty times—the answer is still *one!*

Next, imagine a box—inside measurements *one* foot high, *one* foot wide and four feet long. Its cubic space is $4 \times 1 \times 1$, or 4 cubic feet. Hence, only because one times one is one, the *number* (4) of linear feet of length, is the same as the *number* (4) of its cubic feet of space. And if one uses 4 only as a *number*, then 4 is 4.

In any room of any building, this might not happen once in a thousand times. But it happens that the *number* of inches of the length of the War Passage, is almost the same as the *number* of its cubic feet of space. Its cubic feet of space is a little more than 52, and its length in inches is a little less than 52. One is inches; the other cubic feet. But—since Davidson uses number as mere number, 52 is 52! Hence if you assign a month of time, to each unit of the *number* 52, the answer will be the same whether the unit is inches or cubic feet.

The true time in the Passage should be determined by its cubic space. And Davidson uses the one-line length only, yet in this one case his time period happens to be almost correct, because 52 is 52.

There is also the question of the accuracy of Davidson's calculation. One of the few cultured and careful, as well as devoted followers of Davidson, earnestly tries to correct Davidson's errors in calculation. No human mind is perfect, and errors of calculation will occur. But an important mathematical error, representing a difference of seven days, *overlooked for sixteen years*, gives

one no assurance that there may not be many other overlooked errors. Then also changing the date of the prophecy—putting it forward seven days— and then having nothing of importance happen on that date, is not satisfying.

There is also the question of consistency of data. In Davidson's work, a measurement exact to $1/1000$ of an inch may be given on one page for a designated distance, then on another page, a different measurement for the *same* distance. Nevertheless, Davidson merits great commendation for his monumental presentation of mathematical and astronomical data, related to the Great Pyramid.

APPENDIX FIVE

ERRORS OF DAVIDSON'S FOLLOWERS

Each author, who has written of the Pyramid, holds that his prophesied dates are unquestionably correct, because they are determined by Pyramid measurements exact to either $1/100$ or $1/1000$ of an inch. Hence, we expect him to use correct data, with exactness, and not carelessly. It is not personally pleasant to call attention to errors, but unless it is done, thinking readers may lose faith in the truth revealed in the Pyramid itself.

One chart of the Pyramid, by a follower of Davidson, gives the coffer's inner measurements, exact to $1/100$ of an inch; and by his figures its inner cubic space is exactly 71,316.59 Pyramid cubic inches, or 71,550.43 in our cubic inches. This author then states that this coffer can hold exactly 2500 TONS of water! What are the facts? One gallon of water occupies 231 cubic inches of space. Hence, the coffer can hold 309.7 gallons of water. But 309.7 gallons of water does *not* weigh 2500 tons. If this author's statements were true, then each QUART bottle of milk would weigh more than 2 TONS!

Another follower of Davidson writes that the British inch is $11/10,000$ shorter than the Pyramid inch; and still another states that the British inch is $11/10,000$ longer than the Pyramid inch. Another vividly compares the cubic feet of stone in the Pyramid with the amount needed to build a great stone highway. But using his data, a schoolboy discovers, that this author has made an error of 235.5%.

Another book states that at the base of the Great Step, the time scale changes to one inch per month. The height is 36 inches, and hence, the time is 36 months—that is, 3 years! But on his next page, he states that this time extends from January 25 of 1844 to August 2 of 1909—and that is more than 65 years! Another Pyramid writer states that 'thousands' of its stones are almost as tall as the average man. That is an exaggeration similar to stating that thousands of our college boys are eight feet tall!

Then there are errors due to *twisted* figures. One writer twice

emphasizes that the cubic inch space inside the coffer, is *exactly* 28.5 times 2500. By his own figures, the cubic content is exactly 71,316.59 cubic inches. But this is NOT 28.5 times 2500. So, half way down the same page, he forgets his exact figures, and uses 71,250 cubic inches. This makes his idea come out as he wants it—for 71,250 is 28.5 times 2500. The text of another book gives the side length of the flat top, as 432"; but on the accompanying chart, it is 572". This last figure is like the exaggeration of a gossip, who whispers that you weigh 203.9 pounds, when your true weight is only 154 pounds.

Let us forgivingly forget errors of fact, twistings, and exaggerations; let us build our faith on the *truth* of the Pyramid itself.

APPENDIX SIX

TELEOIS NUMEROLOGY

The only perfect and certainly the highest spiritual—concept of numerology is found in the symbolism of the Teleois numbers and the Mystic Triple Cross in the Pyramid.

It is probable that all systems of numerology, which are supposed to have come down from Pythagoras, did NOT come from him. They were 'created' several hundred years after he lived, by partially informed teachers of the middle ages.

Since the Teleois numbers from the long lost Canon of Polykletos, since they were used to determine the structures of all great temples of Greece and Egypt where Pythagoras lived and taught, and since they determine the intervals in the musical scale on which Pythagoras based his science of numbers, it is certain that Pythagoras must have known and taught the Teleois proportions. They are so perfect that even distances of the solar system accord with them. They form the only basis of perfect numerology.

APPENDIX SEVEN

DETERMINATION OF DATES OF THE HALL OF UNITY

The following is written only for those who wish to consider the tedious mathematical steps of confirmation of measurements and determination of time periods and dates. For this purpose, as examples, I here use the height of the Hall of Unity, its time period in number of days, two of its important dates, and the nature of the events of those dates.

First, its height: The ancient manuscript scrap says—“*The seasons of its height shall be like unto the space of the moons of the circle of days.*” Since ‘space’ always means the square of a number, the space of the moons is the square of 13—that is, 169. But 169” is NOT the height of the Hall; and the revelation does not state that it is. It says this 169—space of the moons—is like unto the seasons of its height—that is, 4 times its height. Hence, divide 169” by 4, and the answer is 42.25”. This IS the exact height at the south end of this Hall, which varies 118 ten thousandths of an inch from the *average* height (42.468”) usually used.

Second, determine the time-period of this Hall. *The number of days is “like unto the fingers of the moons of its cubits.”* This seems intricate at first. But *cubits* means its cubic space; *moons* means lunar months. The cubic space is 5.91 sacred Egyptian cubic cubits. A lunar month has 28.096 days. *Fingers* always means 10—because of the ten fingers on the two hands. Hence, $5.91 \times 10 \times 28.096$ days, gives us the number 1660.331 days—1660 days!

The sacred records reveal this same number in another way, so that there might be no possibility of error. “The time shall be like unto the space of the seasons of cycles of the sun, added unto the Sabbath of perfections of its moons.” If you use the numbers of the meanings of these terms—see Chapter XV, Strange Phrases—you obtain the same 1660 days!

Third, determine two dates. The space¹ key of this Hall reveals that its Teleois proportions are 1, 4, 7, 13, 19. The sum of these is 44.

In this Hall of Unity, the total of all the days of the first 44

¹ In the drawings in this book, circles represent spheres; and squares, cubes.

basic units of the Teleois circles—1, 4, 7, 13 and 19—is 1660 days. Hence, in *round numbers*, the basic 1 Teleois Circle represents 37.7 days; the 4T circle, 151; the 13T circle, 490; and the 19T circle represents 717 days. Then, there are the circles within the circles. And, for example, the 13 secondary T circle of the 13T basic circle, represents 144 days—that is, $\frac{13}{44}$ of $\frac{13}{44}$ of 1660 days.

Graphically, in the Hall of Unity—as shown by *Figure 9*—these circles drawn in it occupy the same space that is symbolized by the 1660 days.

It is impossible here, in limited space, to show how more than one or two of the dates are determined. Let us consider two—October 27, 1917, and November 9, 1918.

Please note, these dates are NOT at first known. We have to discover them. But four facts are known: the structure of the Hall; its exact measurements to 10,000ths of an inch; its Teleois proportions revealed by the measurements; and the total number of days revealed by the cubic space of the Hall.

In the maze of circles of *Figure 9*, you see contacts of one circle with another, and many intersections, and some are emphasized by appearing above or below each other. ONE of these, because of such emphasis, seems to represent an important day. Let us determine *what* date this point of intersection represents.

THIS point of intersection is made by the *first* unit of a 7T circle, of a 13T circle of a 13T of a 13T of a 19T circle. Since all the circles exactly fill all the space of the Hall, the diameter of each circle represents its proportionate number of days of all the days. Adding the number of days of the Teleois circles preceding the point—that is, the days of 7T of 13T of 13T of 13T of 19T—we have 1218 days. Adding this number of days to the initial date of June 28, 1914—which must likewise be previously determined—the 1218 days take us to October 27, 1917.

Determine next, whether or not this date—October 27, 1917—was one of particular significance. In the year 1917, the First World War was being fought. Does this date symbolize anything of importance in the progress of the World War? And if you were back in 1890 determining this point among these circles and the date it represents, you would not at that time know the nature of the event forecast. So let us, by its Teleois numbers, determine if we can the *nature* of the event.

Remember that this intersecting point was determined by Teleois circles—7T of 13T of 13T of 13T of 19T. Remember also that the ancients used *resolution* of numbers to signify

meanings, not mere sum totals of digits. So if, back in 1890, you had wished to get some idea of the *nature* of the event which was prophesied to take place on October 27, 1917, you would have first resolved all the 13's and the 19, and then interpreted them.

The 13 resolves to 4; and the 19 to 10, and then the 10 to 1. Hence, by resolution, the above designation becomes the first day of a 7 of 4 of 4 of 4 of 1.

And now, what meanings did the mystic wise men give to such basic numbers?

The figure 7 represents the height or PERFECTION of an action, such as the Sabbath day in creation. The figure 1 always represents original or creating power, as in all early religions. Sometimes 1 is used to represent God; sometimes, Life; but always to represent the CAUSE of a condition or action. The figure 4 always represents ACTION or form.

Hence in the Teleois figures 7, 4, 4, 4, 1—the 7 is the *perfection* of something; that something is 4, *action*; and very important action because it is repeated three times; and since the 1 follows the 4's, the 4's produce a final result that is like the original cause or purpose of the action.

Does this reveal the *nature* of the event of October 27, 1917? It is the day when the first troops of the United States went into *action* in France. It WAS the day of the *perfection* of new ACTION—very important action, which determined a RESULT which was like the ORIGINAL aim of those with whom the American soldiers were fighting.

Next, consider November 9, 1918—fixed by intersection of Teleois circles—as the first day of a 19T of 19T of 13T of 19T of 19T of a 19T circle. If we were back in 1887 and wanted to know what would be the nature of the event which would take place on November 9, 1918, we would resolve 19 of 19 of 13 of 19 of 19 of 19, and interpret the meanings of the resolutions. Each 19 resolves to 1; and the 13 to 4. The action is represented by the 4. The *cause* and *result* of the action are represented by 1's. Only *one* 4, and five 1's; and three of the 1's after the action!

Evidently whatever had caused the original action, emphatically STOPPED causing action; yet continued for years, but caused no more action.

November 9, 1918, was the day of Kaiser Wilhelm's flight into Holland. By that flight, the initial cause of the action of the war ceased to cause any more action; the Kaiser lived on, but never caused any more action!

APPENDIX EIGHT

THE GOLD WAR, 1921-1933

This Appendix continues Chapter XXI in which I stated that the War for Gold was our *Second World War*, that it was so *secretly hidden* that it was not recognized as a war; that it lasted 13 years, 1921-1933, and that it wrought greater destruction of values and ruined more millions of lives than any other war of history.

What follows is a continuation of the above; it gives *facts* and the sequence of *events*.

This War for Gold was planned and directed by eleven Machiavellians—international financiers and munition dealers. Their ultimate aim, as previously stated, was to control the world's gold, so that they could control international credit and monies of all nations, and thus be able secretly to collect hidden racketeering profits on all important industries and world commerce—from both workers and bankers of more than forty nations and a thousand million peoples.

After the first World War, because of the gold of reparation payments flowing to the Bank of France, the Machiavellians made that bank their bank of deposit and operation for their vast deals in Asia and all central and southern Europe. By 1921, by threat of withdrawal, they had gained sufficient influence over the Bank of France to make it temporarily do their bidding. Thus they could control funds and credit which they could use to manipulate \$12,000,000,000 worth of short-term liquid¹ securities on the stock markets of the world. With such manipulation, it was possible to bring panic where and when they pleased. Since in practice the Bank of France is the bank of the French government, the Machiavellians often made their own secret operations appear as though they had been initiated by the bank or by the government itself.

There were **FOUR CAMPAIGNS**: first, 1921 to 1923—3 years;

¹ Conservatively estimated at 2500 million pounds sterling in *The Rise and Fall of the Gold Standard*, by Sir Charles Morgan-Webb, p. 115.

second, 1924 to 1929—6 years; third, 1930 and 1931—2 years; and fourth, 1932 and 1933—2 years.

VICIOUS MEANS USED

The METHOD was always the same.

First *strip* a country of necessary resources, or manipulate its money or short-term credits until the country was near financial and economic collapse, and its people near starvation.

Second, *make loans* to the stricken country, accompanied by 'special agreements' which obligated the stricken nation to increase its armament and to purchase such armament and all other military equipment—and food also—at extraordinarily high prices, from powers associated with the Machiavellians.

Third, *get back the money loaned*—by collecting ALL of it in payment for food or military supplies. Thus the stricken nation—again stripped of money and its loans still unpaid—found itself still obligated by treaty to make more armament purchases and—although it had no money—to pay, pay, pay!

Then fourth, *repeat these processes if necessary*, and then, with the stricken nation near final collapse, *refuse* more loans, demand payment, and start *sudden withdrawal* of gold or liquidation of short-term credits which the nation had been induced to build up.

The Machiavellians often modified these steps to fit the nation attacked; but the method was always effective. For when a nation's Treasury and its banks are near collapse, it will—to save itself and its people—be 'willing' to agree to almost any proposal made.

THE NATIONS FIRST ENSLAVED

The FIRST campaign lasted three years, 1921 to 1923. It began with Austria—previously stripped of means of self-support. "*Her economic resources were so reduced, that by 1921 her people² were starving.*" Then loans were made, *but for six months only, with refusal of additional loans.* Month by month, more was taken from Austria; soon she was forced to sacrifice banks and railways, and secretly surrender supervision of her army. Every attempt at real help—by removal of tariff barriers, et cetera—was prevented.

² *Brief History of the League of Nations*, by Helen Clarkson Miller, p. 73.

Nevertheless, the League of Nations did noble work! For years it functioned as a Red Cross to Stricken Nations. But the clever Machiavellians, unsuspected, *used* the League—and high officials of nations, too—to cover up their operations.

Hungary also was stripped and beaten down financially, until by 1923 it was put under international financial supervision. Then *Greece*, *Czechoslovakia*, *Yugoslavia* and *Bulgaria* had to sign military or special trade agreements to get loans.

Germany came next; and—no matter what our own personal prejudices—we must face truth. Germany had been stripped of essential resources in 1919. In *western* Germany, Saar coal, Lorraine iron and Aix-la-Chapelle mines had been taken away. Later, in *eastern* Germany, by May 1922, 75% of the Silesian output of coal and the great steel works, were given to Poland.

This was engineered by the Machiavellians. German peoples of Silesia had been promised that they would be given the right of self-determination. So they were allowed to vote, and they did vote to return to Germany. But the Machiavellians saw to it, that the promises of fifty-one nations, the promise of the League's Council, and the promise of the Council of Ambassadors—all *were broken!* No matter how the people voted, the Silesians—with their mines and industries—were handed over to Poland. Then in 1923 France seized the Ruhr manufacturing section. Hence, both in the west and the east, Germany's major industries were paralyzed; millions out of work, needing food to live.

THREE FOURTHS OF EUROPE

The first campaign of the Vicious War for Gold was successful. *France* was controlled through intimidation of her central bank. *Austria* was covered by a general blanket mortgage—everything gone. *Germany's* wealth had vanished; her money had been inflated, and then deflated to zero. *Hungary* in desperation was subservient, and all *Balkan States* were under control. Bankers of *Switzerland* and *Holland* and *Belgium* had become gold slaves because of threats to ruin their monies as Germany's had been destroyed. To the north were the Scandinavian states, each with a population less than that of New York City.

Hence, excepting only these and Spain, England and Italy, *all Europe was in the hands of the vicious Machiavellians at the end of 1923! The first campaign was successful.*

RUINING PROSPERITY

The SECOND campaign lasted six years, 1924 to 1929. There is space here only for its high lights. Some conditions early in 1924 were not quite satisfactory to the Machiavellians, for earnest men—like truth crushed—will rise again. An International Commission reported that "Never was the outlook for a return to worldwide prosperity brighter ³ than in 1924." Germany began to recover; established a gold mark whose value she has maintained; and the same year, the Dawes Plan was put in operation.

Then also, Czechoslovakia was not as servile as the Machiavellians wished. She was even working for world peace. That would mean no great munition deals. So when Czechoslovakia proposed a disarmament conference, pressure was brought on 'powers' in England. The British PEOPLE wanted disarmament and world peace, but on March 12 of 1925 in the Council of the League of Nations—*Chamberlain, himself, emphatically rejected* Czechoslovakia's proposal for disarmament!

Since the Council is constituted so that ONE veto vote can prevent any action, Chamberlain *alone* by his rejection was able to shatter the hope of disarmament. Immediately all nations became so apprehensive that they rushed to buy munitions to prepare for more wars—exactly what the Machiavellians wanted. England herself was not yet completely conquered. The British people did not know what was going on. A few leaders were scared by threats to England's money which they were struggling desperately to make the unit of value for all monies of the world. By what they did, it seems these few men were scared into partial co-operation—see subsequently, *Chamberlain's* action at the World Economic Conference.

Across the ocean was the *United States*, still the richest nation, and still enjoying remarkable prosperity. Because of her prosperity, gold was flowing *from Europe to America*. At this time, May 16, 1925, the United States asked European nations for a war debt settlement. That would mean a greater flow of gold to the United States, and that had to be prevented. So September 23, 1925, the Premier of France arrived in New York and went to Washington, to arrange for reducing and funding of these debts.

Later other factors increased flow of gold to the United States.

³ Macmillan Report.

The Machiavellians had forced France in August 1928, to devalue her currency "to the enormous⁴ extent of 80 per cent." This made European bankers fear for the stability of their own monies. Then also, the Young Plan was put into effect August 1, 1929. It turned considerable gold from the United States to Germany. European bankers soon saw that the gold sent to Germany was being grabbed by France, by the unconditional right given her by the Young Plan. They remembered German inflation in 1923 and French devaluation in 1928, and they were again scared. They also knew of the amazing prosperity of the United States in 1928 and early 1929. So they sent more of *their* gold to the United States.

At this point, the Machiavellians realized that gold would continue to flow to the United States, *so long as* it was prosperous. Hence, the only way to stop the flow, was to convince European bankers that the United States was NOT prosperous. The only way to destroy prosperity was to create a panic and depression.

So early in August, 1929, they began secret manipulation of the \$12,000,000,000 short-term liquid securities, operating under cover in all security markets of Europe and the United States. Security prices in the United States were already overinflated, so it was easy to execute their plan.

They succeeded! We cannot forget their success—the stock market declines and crashes of September and October of 1929,—\$50,000,000,000 loss of values in one day! The second campaign of the War for Gold was won!

THIRD CAMPAIGN—THE LAST DROP

Some financiers began to think that the stock crash of 1929 had been started abroad. This made the Machiavellians hesitate. They did not wish the United States to suspect what was being done, until a moratorium or annulment of European war debts to us had been secured.

Hence a number of cover-up movements were started. The Machiavellians influenced the Bank of France to influence the French government to evacuate the Rhineland; and they inspired the Council of the League of Nations to announce on January 23, 1931—after twelve years of promises—that it *would* hold a disarmament conference.

⁴ *Rise and Fall of the Gold Standard*, by Sir Charles Morgan-Webb, p. 102.

After this 1930 year of cautious effort, there seemed—in the spring of 1931—"to be a definite easing of economic and financial conditions . . . there was some return flow of capital to Germany."⁵ Germany had also been keeping the gold obtained under the Young Plan for six months, *before* handing it over to France, and began rebuilding her industries. Early in 1931 the Bank of International Settlement reported that conditions were much improved.

This was NOT what the Vicious Gold War leaders desired. They wanted to scare the United States by threat of collapse in Europe, so that we would pour more gold into Europe. They also wished to secure some form of practical annulment of war debts. *The only means of creating such a scare was to bring Europe near to collapse again!*

So a gold drain was started.

This was started in Austria and Germany. By May 1, 1931, Austria was bankrupt again, and \$400,000,000 had been drained out of Germany. Sixty days later, by June 1931, \$690,000,000⁶ of gold had been withdrawn, and German business had been so scared that an additional \$830,000,000⁷ German capital had been exported. These last two items totaled \$1,520,000,000—a titanic sum to be withdrawn from Germany, which had been first stripped of resources, then twice financially ruined, and impoverished and starved for 12 years!

To convey the *awfulness* of these conditions to the United States, another European Premier visited America—loudly proclaiming that Europe would collapse, unless the United States did something more. The plan worked. June 21, 1931, President Hoover asked for a moratorium for Germany; and this was soon used as the excuse by the European nations for stopping payments on their debts to us.

Hoover's announcement worked as the Machiavellians had planned. Stock and bond prices zoomed throughout the world. "*World wide advances⁸ in prices added BILLIONS of dollars to open market prices.*" The Machiavellians reaped gigantic profits. But what happened to United States Bonds? "*U. S. Bonds failed⁹ to participate in the move.*" AMAZING! Securities

⁵ *World Economic Survey of the League of Nations, 1931-32.*

⁶ *Wiggin Committee Report on the Financial Crisis in Germany.*

⁷ *America Weighs Her Gold*, by James Harvey Rogers, p. 137.

⁸ *New York Times* Financial Section, June 23, 1931.

⁹ *Other People's Money*, by the Chemical Foundation, Inc., p. 53.

boomed everywhere in the world. *YET, U. S. Bonds were kept below par!*

The Machiavellians were now ready: to conquer England completely this time, and then to 'get' the gold of the United States. They did not wait; within ten days after the Hoover moratorium announcement, by use of short-term liquid credits, they began withdrawing gold from England. Although in June 1931, London had a gold reserve¹⁰ of \$730,000,000—yet by August she was twice compelled to borrow hundreds of millions from France and the United States. "More than \$200,000,000 of short-term funds were withdrawn from Britain¹¹ in less than four days." And the British Chancellor explained to Parliament that the withdrawal was "predominantly on *foreign accounts*."

The Machiavellians *used* France, and France used the gold standard as "a fairly efficient suction pump¹² . . . to drain every ounce of gold that was not securely protected against her acquisitiveness." In 1931, France and her gold associates withdrew "three times the amount of the total production from the gold mines¹³ of the world for that year." France was successful in "*denuding a distressed world of the last remnants of available gold.*"

On September 21, 1931, Great Britain was forced to her knees, compelled to go off the gold standard. The gold standard was in ruins. In Europe, France had the gold; but other than Italy, only six minor European nations were able officially to hold on—in Asia only two, Turkey and Persia; in Africa, only Liberia!

And within thirty days after England was forced off the gold standard, Laval, Premier of France, was on his way to New York. A staff of newspaper men came with him. The day Laval left France, articles were cabled to New York, telling of utter world collapse, unless the United States did something more to help financial Europe. Laval arrived October 22, 1931, spent two days with Hoover, and announced that the United States would help to maintain gold values; also consider adjustment of foreign war debts.

A great victory for the Machiavellians! "The consequences of events of 1931 are now spread before us . . . lives of millions of

¹⁰ *Federal Reserve Bulletin* for August 1931.

¹¹ *Union Now*, by Clarence K. Streit, p. 276.

¹² *Rise and Fall of the Gold Standard*, by Sir Charles Morgan-Webb, p. 149.

¹³ *Rise and Fall of the Gold Standard*, by Sir Charles Morgan-Webb, p. 152.

people have been affected. The extent of the economic and social disaster . . . may not be ascertained in our generation." ¹⁴

FOURTH CAMPAIGN—U. S. A.!

The Vicious War for Gold was almost won. Only one great gold reserve nation remained financially independent; it was the United States. Our securities were in ruins; our industries paralyzed; our people in want; yet there were still gold and money in our banks and gold in the United States Treasury.

All was ready: the great gold drain of the fourth campaign of the War for Gold could begin, according to plan.

Suddenly the Bank of France notified Federal Reserve Banks in the United States, that France could not leave her earmarked gold in the United States unless the rate of interest was raised. Such a notice from the central bank of one nation to the central bank of another nation had never previously been heard of. Although France owed us \$3,750,000,000 war debt and had \$600,000,000 on deposit here, still she was not paying a cent of the debt. Instead, she threatened to withdraw the \$600,000,000.

And she began doing it!

Already France and her gold associates had been withdrawing gold at an astounding rate. Then during the first five months of 1932, gold was withdrawn at an average rate of more than \$100,000,000 every 30 days!

The Machiavellians desired that Laval's visit should be effective in scaring the United States. And \$20,000,000 were withdrawn in one day—the day after Laval set sail for France! Withdrawals were effected by recalling earmarked gold and manipulating the titanic amount of short-term liquid securities which the Machiavellians could manipulate.

The drain continued; by the beginning of 1933, we had less gold than we had had in 1926! Conditions were becoming desperate. Withdrawal continued at an amazing rate and in gigantic amounts. Banks failed, or were ready to close their doors; and there was hidden panic in the hearts of all.

The Machiavellians had us sliding!

Then on March 4 of 1933, a newly elected President was inaugurated. He immediately asked Congress for power to stem the tide. On March 9 of 1933, Congress gave him power to regulate our money, and on April 19, *he prohibited export of gold!*

¹⁴ Simonds, Pamphlet 77, Foreign Policy Association, December 1931.

Next he proposed that a World Economic Conference be held in London, to arrange that gold should be used *to stabilize prices of the products* of the industries and commerce of the world, to the end that production in all nations might be put on a more prosperous and profitable basis.

Note this carefully: it is the key to the final defeat of the Machiavellians. Roosevelt's proposal was that all nations should agree on the use of the gold of the world, to stabilize world *prices*. This was in accord with the findings of the Macmillan Report, which recommended that "The main objective . . . should be to maintain the stability¹⁵ of international *prices*." Roosevelt's proposal was also similar to the aim of the Currency Conference of the British Empire, held in Ottawa in 1932. Both the Macmillan Report and the Ottawa Currency Resolution supported Roosevelt's position. "They both proclaimed that stabilization of prices, NOT stabilization of exchange,¹⁶ was the primary objective."

The World Economic Conference met in London in June 1933. Chamberlain of England was chairman. Our delegates were there, and although Roosevelt had gone to Campobello for a short vacation, he kept constantly in touch by transatlantic telephone.

Remember, the Conference had been called to agree on stabilization of *prices of products*—to help workers and producers, traders and bankers of the world. But as soon as it met, this was *opposed* both by Chamberlain and France.

Great Britain—or rather Chamberlain¹⁷ and a few men in London—wanted the United States to pledge our own gold so that it could be used to stabilize *England's* money unit, and make it the basis of all monies of all nations.

France not only urged, but *demand*ed that the United States pledge itself to use of our gold to stabilize European securities

¹⁵ *Rise and Fall of the Gold Standard*, by Sir Charles Morgan-Webb, p. 132.

¹⁶ *Ibid.*, p. 155.

¹⁷ Chamberlain's action is still unexplained. Official Delegates of the British Empire to the Ottawa Conference had adopted resolutions in favor of the stabilization of prices which Roosevelt advocated. Since this represented the wish of all British peoples, it was expected that Chamberlain would try to carry out the decision of the Delegates of the Empire. But surprisingly, he opposed price stabilization. His action was evidently not approved by the British Delegates, for immediately after the World Economic Conference, they issued a Manifesto restating their Ottawa decision in favor of stabilization of prices.

markets in which France was interested—the stock exchanges which the Machiavellians could easily manipulate!

These plans and demands were so different from the initial purpose of the conference, that our delegates did not know what to do! Roosevelt also—closely in touch with our delegates—was first amazed and then began to realize the use Europe wished to make of us.

Something else in these days was moving over the face of the earth. A great wave of spiritual intuition was awakening men. The great spiritual powers, now consecrated to making the Americas the shrine of high idealism and the center of the great new civilization, were particularly inspiring man during those few days. Their inspiration was centered on a few men, who began to realize that something *new* must be done. The attempt to adjust old conditions was not sufficient to remedy the lacks in economic life, or defeat the vicious power directing the War for Gold.

In one night, the vision came clear.

In answer to France's first request, Roosevelt had cabled a courteous but firm refusal. The Machiavellian powers could not believe it! It was incredible that one man alone could have courage to oppose them, and risk the world collapse which they threatened if their demands were not agreed to. So another request was sent to Roosevelt. Either by worldly knowledge or mystic clarity of vision, he saw clearly what had been done during the preceding thirteen years, and what he must do! To the second request he replied bluntly, that their proposal was "a purely artificial and temporary experiment *affecting the monetary exchange of a few nations only,*" and recalled our delegates.

This was the beginning of victory! The Machiavellians in the Great War for Gold had been routed. It was titanic! To the Machiavellians it was catastrophe. Roosevelt made July 4, 1933, a day for another declaration of American Independence.

And on that day, in the Temple of Initiation in the Great Pyramid, the number sign of gold is again *united* with the sign of divinity!

There were no more battles—but one last desperate effort was made by the Machiavellians. It was to deflate all monies of Europe to almost zero, so that our world trade would be ruined unless we provided the gold to re-inflate foreign monies. A whispering campaign of what Europe might do, was started. The reader should understand that every nation's money has two values—one in its own country; and another, abroad. All other

nations had greatly devalued their monies. Consequently, in foreign exchange, we had to hand out our good money, for their poor money. Now still greater devaluing of their monies was threatened. There was but one thing for us to do. So, without depreciating the home value of our dollar, its gold content was lessened for exchange abroad. With the consequent increase in price of gold, all the world realized that billions of gold would flow to us. The Machiavellians¹⁸ now knew they were defeated; they could never gain control of the billions flowing to us!

It may be a generation before we realize the tremendous significance of this victory. For 98 years, 1816–1914, England had controlled gold and used it—and used the gold of other nations—to make *her* money unit the basis by which the monies of all other nations were valued. After the First World War, 1914–1918, the Machiavellian Powers had used gold as the basis of controlling and manipulating prices of stocks and bonds in the markets of the world. Remember that for a hundred years—making *one* nation's money dominant, or manipulating stock exchanges—had been the two purposes for which monetary gold had been used.

THEN by his act of July 3, Roosevelt initiated on July 4, 1933, *a NEW use of the gold of the world—based on the ideal of using it, to stabilize prices of the products produced by man and exchanged by him in all parts of earth!*

Each important date of the thirteen years of this War for Gold was symbolized 4800 years ago, by the structures of three chambers of the Great Pyramid! Such was and is the wisdom and vision of the Order of the Wise Men of old and of today!

¹⁸ Four of the Machiavellians have since died supposedly of natural causes; two committed suicide; three who later went to Germany, hoping to gain control of the new gold mark, have disappeared in concentration camps; the two still living, are defeated broken men, in exile—men without a country.

APPENDIX NINE

ACTION LEADERSHIP

The experienced executive and the thinker will find much in each paragraph of this Appendix, which I include because I wish you to know the nature of action leadership¹ and why the need and demand are so great today.

There are FOUR functioning units of human society.

They are (1) the individual, (2) the team, (3) the crowd and (4) the organization. (The organization is not a true unit, but a composite of teams *and* crowds.)

The NATURE of a human unit is determined by its *function*, and not by size.

The strongest appeal to the individual is by motive; to the team, by action; to the crowd, by ideals and feelings; to the organization, by ideas and action.

Of the four units, TWO are discussed here—team and crowd.

The CROWD'S SIZE is variable: three or four people may make a crowd; or the crowd may be immense—up to millions if they are listening to a leader speaking over the radio.

The TEAM'S SIZE is very limited: two people might form a team, but the most efficient team consists of six or seven members. If, however, twenty or more people *attempt* to act as a team, they unconsciously take on the nature of a small talking crowd, and their talk often creates dissension within the group and prevents efficient action by the team.

A COMMITTEE may be a crowd or a team. If it is a discussion committee, it is a crowd. If organized to DO something, it *should* be a team; but usually it talks so much that it seldom acts like a team.

OPPOSITES in nature and in function differentiate the team from the crowd and *vice versa*.

The TEAM is the *action-unit* of society. It is fitted for action and action only. Talk disrupts it. Example: every committee you have tried to get to do something. Although all talk in the team lessens or destroys its effective action, yet as soon as its members

¹ *The Means which Guarantee Leadership*, by Brown Landone.

are out of action—as when members of a football team are in their dressing rooms or clubhouse—they are no longer functioning as a team. At such a time, talk is not necessarily disruptive.

The team is the **ONLY** unit of human society—other than one individual—which can act efficiently. It was born for action, long ages ago. Whenever a few men wanted to DO something, they accepted the unquestioned command of one person. He made all decisions; gave all orders; the members obeyed in action; discussion was not allowed; the result was super-efficient action.

The CROWD is the *idea* or *talking unit* of human society.

A crowd forms, whenever there is a common *interest* or *feeling*. The crowd is fitted for *talk* and talk only.

Whenever the crowd attempts action, it tramples on its own members and destroys the very thing it wishes to attain or save. Example: 1000 people trying to put out a fire; they trample on each other, and the building burns. Or imagine 5000 people of a football crowd rushing down from the bleachers to the field—trying to act as a team to play the game.

The TEAM LEADER must be a man of action. The team insists on it; it will not tolerate a talker.

The CROWD LEADER must be a man who can interest the crowd in ideals and awaken its feelings.

STABILITY and PERMANENCY are never found in the crowd. The crowd is an idea unit, it holds together only as long as it has a common idea and changes with each change of the common idea. Ideas are the most instantly changeable things on earth. So the crowd is always a temporary unit, and often a rapidly changing unstable unit. A cry of 'fire' can instantly change a crowd. Even under normal conditions, the crowd breaks up as soon as its interest ceases to be a *common* interest. A football crowd is held together only by its common interest in the game. Once the game is over, and common interest vanishes, the crowd disintegrates and disappears.

The crowd is so unstable that man can *never* depend on it.

Permanency and stability ARE tendencies of the action team, because action is the basis of habit and habits are fixed tendencies and therefore stable. The team is more *permanent* and *stable* than any other human unit. In human society, it is the **ONLY** basically stable unit, on which man can depend. *Our present condition is dangerously near disintegration because the team has almost disappeared, except in sport teams and armies.*

In **MANAGEMENT**, the executive should be both a team

leader and a crowd leader, and *never* try to be both at the same moment. As a team leader, he should make each member of his team, a leader of a sub-team, and lead that leader to do the same, et cetera. Thus the executive can transmit his action-leadership throughout a great organization. Carried out effectively, this results in an exceptionally efficient organization. But when the head of an organization talks *a little too much* to his sub-executive team, its members talk *much too much* to their subordinates, and the result is wasted energy, loss of time, inefficiency, work not done, and dissension.

IN DEMOCRACIES, human society—in the last 50 years—has become *talking society*. Hence it has lost much of our former power of action. Its former hundreds of thousands of working teams (gangs) each under a (boss) action leader, have disappeared. The members now work as individuals. Today their action is not controlled by a leader, but by a conveyor belt.

In place of enough stable teams, we now have too many talking crowds. This unbalances human society, for the talking crowd is its most unstable unit.

The great demand today—in every kind and size of organization—is for action-team leaders. Human society has never before in history been so weakened by talk by so many talking crowd leaders. Human society has never had so few action leaders. Action-leadership is more needed and offers greater opportunities than at any previous time in all history.

APPENDIX TEN

FUTURE DATES

After the manuscript of this book was in galley print form, I received a letter from the publishers, asking me to add more dates of the next few years. I had hesitated to do this when writing the book because it often takes weeks to make the mathematical calculations necessary to determine a date with exactness and certainty, and the need of issuing the book at once, was evident. More time should be given to make certain that no error has been made in the arithmetical operations of these new additional dates, for each is based on cubic space, exact to millionth parts of both cubic cubits and inches. The *first* hour of each day should also be more carefully checked, for it determines if a date—as of the meridian of Gizeh—is a day earlier in New York, or a day later in Tokyo.

The following, however, are a few of those now determined with a fair degree of exactness: November 4 to 12 and 29, 1940; January 30, March 6, May 16, June 4, July 26, November 21, 1941; March 6 and 7, May 21, 1942; January 30, March 6, May 19, August 9, 1943; September 9 and 16, October 27, 1944; March 6, May 16, July 26, 1947; April 17, 1960. This last date, calendographers tell me, will be an Easter. I do not at present indicate the nature of what will happen on these dates. That will require additional work in 'resolution' of numbers. Within the year, I hope for time to do this.

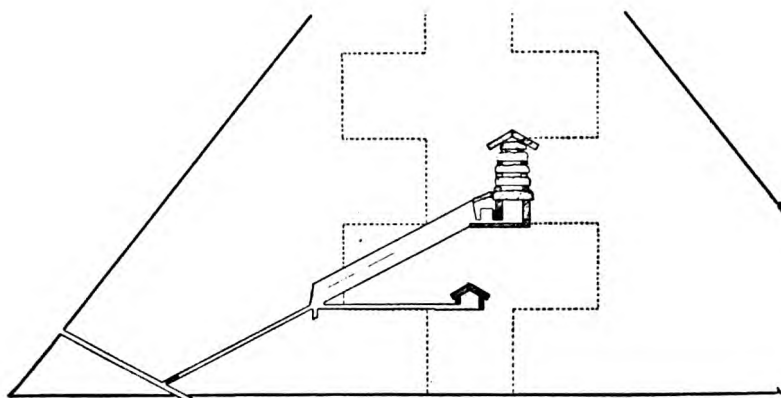

FIGURE 1

INNER STRUCTURE OF PYRAMID

The Chinese write and read from vertical columns of signs, from top to bottom, *down* the page. And to us, the Jewish printed page is hind end to—that is, it is read from right to left.

Most illustrations of the Great Pyramid given in books previously published, have been drawn so that we have had to view them in the Jewish way—that is, from right to left. This is opposite to our modern habit of reading; so a change in the illustrations of the Great Pyramid has long been needed.

In this book, the change is made; all Figures are drawn to accord with *our* modern habit of reading from left to right.

Figure 1 shows the outline of the principal passages and chambers within the Great Pyramid: first, there is the inclined Descending Passage from the outside opening; next, the Ascending Inclined Passage leading upward to the Great Hall of Progress; then the horizontal Passage to the right; and the Temple of Mystics at the end of that horizontal Passage.

Then take your eye back to the top of the Ascending Passage; to the largest room in the Pyramid; it is the Great Hall of Progress, with both floor and ceiling inclining upward; next comes the Great Uplift; then the Altar Platform; then the Hall of Unity, leading to the Temple of Revelation and the Hall of Adjustment. The Temple of Initiation comes next; followed by the Hall of Transforming Action; and lastly the Great Temple of Transfiguration at the extreme right, with its superstructure of great stone beams.

In this last Temple, the Altar-Ark of the Holies of the Living Dead is placed. "Holies of the Living Dead" was the term used by the mystic wise men to designate the "Books of the Knowledge of Those Who Have Passed On and Are Living Forever."

FIGURE 2

GREAT HALL OF PROGRESS

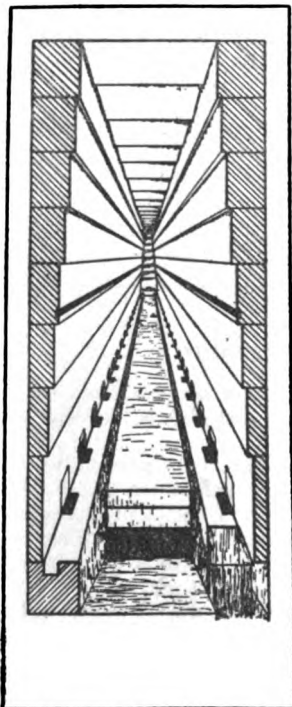

The size, magnificence and upward sweep of this Great Hall of Progress are indicative of its importance. It is the largest chamber of the Great Pyramid—that is, the largest which has been opened to this date.

The importance of this Hall in man's progress and its symbolism of the greatest civilizations of earth are not mentioned by many who write and lecture of the meaning of the Pyramid. They emphasize the three feet of the vertical step at the far end. That, however, is insignificant compared to the Hall itself.

The view you see in this sketch is upward from the lower or north end of the Great Hall. The height of the dark shaded portion near the bottom near you, is as high as a man's shoulder. And a man's head would scarcely come to the top of the first white block of the inclined floor.

At the top of the vertical step—which you can scarcely see, away at the far end of the sketch—is the *Altar-Platform* of Aetheric Consciousness. From this Platform man can look back over 23,632 years of progress, and upward and forward to great heights of attainment. All of this is symbolized, and definitely dated, by the stone projections of the structure.

The entire Hall is built to symbolize the greatness of man's progress. The ceiling is approximately twenty-eight feet from the floor. But it seems much higher. When you look forward, toward the Great Altar-Platform—one hundred and fifty-two feet away—the inclining rise of the ceiling makes you feel that the Hall is sixty or even seventy feet high!

Magnificent as is the increasing impression of actual height, yet the seven long lines of the seven tiers of stone, and the Hall's symbolism of ever expanding consciousness, are more magnificent!

FIGURE 3

ONE-LINE DATES

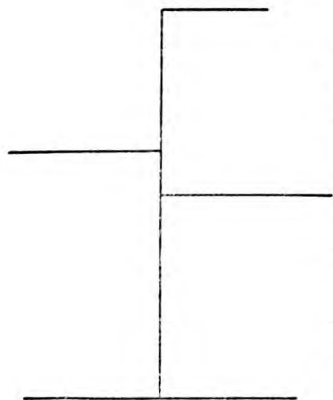

Study the eight lines of *Figure 3*. Are they the lines of a plan for an army push, or of the spread of the Gulf Stream as it flows from Florida Straits? Neither one!

Those eight lines are the exact lengths, and all the lengths, of all the rooms of a little eight-room bungalow. But since they are only one-line dimensions, you have NO idea of what the house would be like.

All the plans of houses you have seen have been either floor plans—in two dimensions, width and length; or picture plans in three dimensions—width, length, and height.

From the one-line dimensions, you can NOT get any clear idea of the house. From those lines you can neither understand it yourself, nor explain it to others. That is

the point; remember it!

Now consider the Great Pyramid. No other people in all history gave such mathematically exact attention to building in three dimensions, as did the designers of the pyramids of Egypt. Every section of the Great Pyramid is based on the exact three-line dimensions of the cube. At NO place in the Pyramid is there any important fact or symbol based on a one-line dimension.

Any attempt to interpret the floor plan of a house from those one-line dimensions of *Figure 3*, might result in a score of errors.

That is why mistakes were made by Davidson in his attempt to interpret the time periods and dates of the Pyramid, by one-line dimensions only! The Egyptians always built on the basis of three dimensions. Hence, one cannot correctly interpret either time periods or symbolism of the Great Pyramid by one-line dimensions, any more than you can understand the floor plan of the bungalow represented by the one-line dimensions.

In this book, all time periods and dates of the Pyramid are based on the *cubic space* of each passage, hall and temple of the Pyramid, because that IS the basis on which the Pyramid was built.

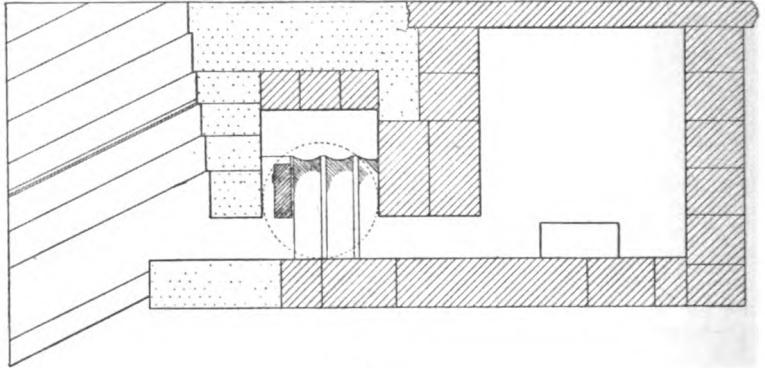

FIGURE 4

UPPER LEVEL TEMPLES

Figure 4: At extreme left, this figure shows a part of upper west wall of the Great Hall of Progress, represented by the *diagonal* lines.

Above the first dotted limestone block at bottom left, is the Altar-Platform of Aetheric Consciousness. The next chamber to the right, is the low Hall of Unity. Then comes the narrow Temple of Revelation whose south wall is formed by the Granite Leaf on which is the Boss—the tiny black spot.

Underneath the leaf is the Hall of Adjustment. Then comes the Hall of Initiation whose west wall shows vertical grooves which were made perhaps for other granite leaves. Next chamber to right, is the low Hall of Transforming Action. Lastly, at right, is the Great Temple of Transfiguration.

Now consider the dotted line bound circle in the middle Temples. Its circumference is exactly 365.2422 inches. This symbolizes the 365.2422 days in our solar year.

How did the human mind *first* discover the value of Pi-3.14159? Or did man first learn what the length of the side of a square should be, to make its area exactly equal the area of a circle of given circumference?

In these middle Temples, the length of the dotted line circumference and the height of the grooves reveal this knowledge. It was probably then known for the first time in history. The area of the circle exactly equals the area of a square whose side lengths equal the height of the grooves.

Think of our haphazardly derived units of measure! We have two kinds of tons; three kinds of miles; nine kinds of bushels by Federal law; and 26 kinds of bushels by state law.

In contrast, the mystic wise men who built the Pyramid used the sides of the square designated above, as the basis of *all* units of measurement. That square is based on the circle, the circle is based on the earth's movement around the sun. *Hence, their units of measurement are exact, and the SAME for all eternity!*

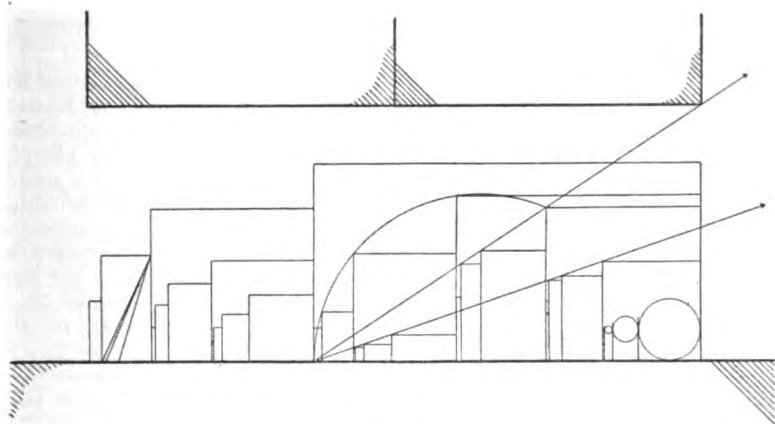

FIGURE 5

HALL OF TRANSFORMING ACTION

Figure 5 is a design of the west wall of the Hall of Transforming Action. But it is so filled with oblongs of Teleois proportions, you may not recognize that it is a Hall. These oblongs are necessary to determine time periods and dates.

You enter this Hall from the left. You leave it at the right. Your first two visions of points in the Temple of Transfiguration are suggested by the vision lines and their arrow points, extending to the *right* and beyond this Hall.

All time periods and dates in this Hall are determined (1) by its cubic space and (2) by its Teleois proportions, which symbolize *the necessity of a unified ideal and a solid four-square basis of action.*

Elsewhere I show how exact these Teleois proportions are, and how definitely they indicate time periods and dates.

The numbers 13 and 31 are perfect Teleois numbers.

The height of this Hall is 42.368807" and its length is 101.033309". These are as 13 is to 31—exact to 1/1,000,000 of an inch.

By these exact Teleois proportions, the oblongs indicate the dates of world important events which have been determined as taking place between August 10 of 1939 and March 6 of 1947, inclusive.

Dates which had been determined late in 1936 were given in private talks up to December 1938, and then in public lectures in June 1939. Dates which were foretold in 1936 include August 9 and 10 of 1939; August 20, 21, 23, 27 and 31, 1939; September 1 and 3, September 20 and 27; October 5 and 6, 13, 14 and 15; and November 5 and 27—et cetera—all of 1939.

The fulfillment justifies the forecast!

FIGURE 6
TEMPLE IN THE ANDES

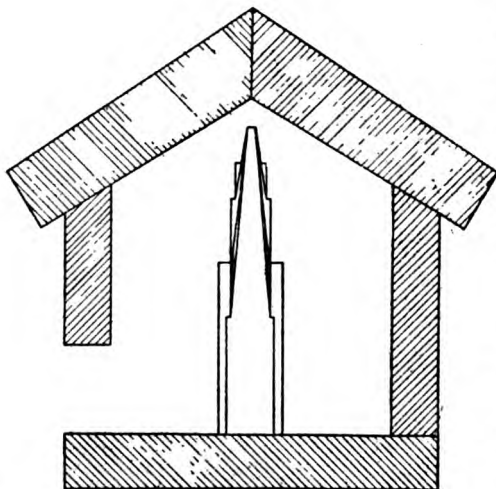

On the west wall of the Temple of the Mystics, there is an unfinished¹ design for a new Temple. Since the design is unfinished, illustrations which have previously appeared do not truly represent its planned beauty. We now know much more of it from one scrap of the Temple manuscript in Drepung.² This instructs the builders to give form to this design in the Pyramid, as the design of a new Temple, which shall be built *after* "4804 cycles of the days of the sun" shall have passed.

Since one cycle of days around the sun is one year, 4804 cycles must mean 4804 years. The mid-year of the Pyramid's construction was 2881 B.C. Therefore, the new temple was to be built 4804 years after 2881 B.C. Of this 4804 year period, 2881 years *had already passed* before the beginning of the Christian era. 4804 years less that 2881 years, leaves 1923 years to elapse since the birth of Christ. This brings us to 1923 A.D.

Another phrase in the manuscript tells *where* the new temple shall be built: "Thou shalt build it over the great water and near the highest of water where the dying sun hath reigned."

The "dying sun" must mean *west* from the Pyramid. There is no great water in Africa west of the Pyramid. Hence the phrase "over the great water" to the west may mean beyond the Atlantic Ocean. In that direction, there is no *high* water until one reaches the eastern Andes. Ages ago the great temples of the Tiajurans and Tiahuanacans were built, near the highest of waters—not far from Lake Titicaca. The greatest temple was that of the *Sun in Gold*; there the "sun *hath reigned*."

We might not accept this interpretation, except for the fact that the holiest of the holy mystics of Thibet returned to the high eastern Andes in 1922. They began building a new temple in 1923; its design is similar to that designed for the west wall of the Temple of the Mystics in the Great Pyramid.

N.B.: Roof and side walls of Figure 6—not to overbalance the illustration—are reduced by 50% of scale used for rest of structure.

¹ See Appendix TWO—*The Mysterious Disappearance of Khufu and the Unfinished Pyramid*.

² Great Thibetan Monastery at Drepung.

FIGURE 7
TEMPLE OF MYSTICS

The units of measurement used by those who designed and built the Great Pyramid were not like the units we use today. Moreover, they were not the cruder cubits, palms and nails used by the Royal Egyptian kings.

This *time space* of this Temple is symbolic of the mystic wise men guiding man during all his progress and attainment. Hence, by the small perfected unit of the builders, the cubic space of this Temple symbolizes *all* the days of *all* the passages and halls and temples of the Pyramid.

This evidence is found in treasured scraps of the ancient pre-Masoudi manuscript of designs of the Pyramid, in the Sacred Libraries in Lhasa and in the Holy Thibetan Monastery at Drepung. In these records, *numbers* are often designated by *phrases*, and *vice versa*. For example, 'the seasons' means 4; 'cycle of the moon' means 28—the 28 days of the lunar month; et cetera.

Instructions are given to build a temple at the *core* of the Pyramid—a Temple of seven spheres of increasing Teleois proportions, from a diameter of 1 to a diameter of 31. To fulfill the condition of 7 spheres of Teleois diameters from 1 to 31, the respective diameters must be: 1, 4, 7, 10, 13, 19 and 31. These spheres, represented by circles in the diagram, determine to 1/10,000 of an inch: (1) the size of the Temple of the Mystics, and (2) the sum of all the time periods of the entire Pyramid.

Within the great sphere of 31—represented by a circle—six other Teleois circles *exactly contact or intersect each other in perfect Teleois proportions*.

In architectural construction, this is a miracle of mathematical proportions. It is something beyond any idea or perfected structure employed by architects today.

See Figure 6, and also text under *Meanings of the Halls and Temples*.

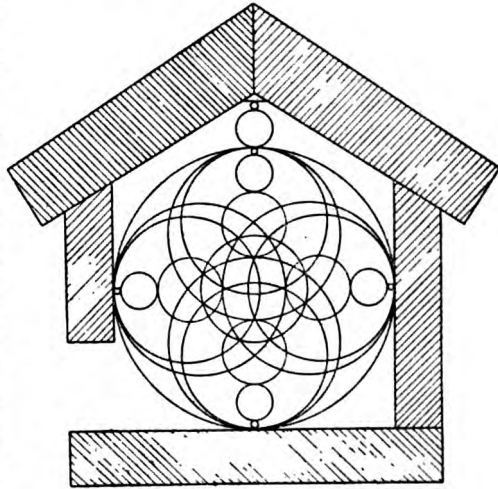
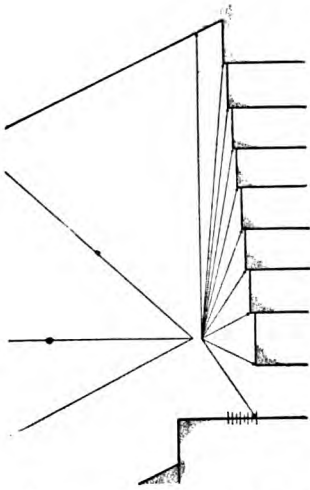

FIGURE 8

ALTAR-PLATFORM



The name of this platform—that is, the Altar-Platform of Aetheric Consciousness—may at first seem strange. But when you read the text, you will realize its significance.

In the 31 years on this platform, more took place to revolutionize man's idea of the atom than had previously taken place in 2243 years! Also, more than half of all man's great inventions of the last 3180 years were discovered or perfected in those 31 years.

The time dates of this platform are definitely determined.

All time periods and dates of the Pyramid are revealed (1) by the cubic space of each hall or temple, and (2) by its Teleois proportions. Then, these are checked by the lengths of its Vision Lines, determined by man's perception along the line of his progress in the Hall or Temple.

To prevent the confusion of the many circles and cubes of space above this Platform, *Figure 8* indicates only the third factor of determining time periods and dates—that is, extension of Vision Lines as from the human eye.

The mystic wise men who designed the Pyramid did NOT depend on such Vision Lines to reveal time periods and dates. But it is evident that they checked the cubic space of each Hall and Temple and its Teleois proportions, in relation to man's actual experience in each chamber.

It is only in this way that Vision Lines are used in this book.

Nevertheless, it IS remarkable that the units determined by Vision Lines are always approximately the same as those of the cubic space and the Teleois proportions. Vision Lines, however, are always approximate because of variations of the human being. In contrast, cubic space and Teleois proportions are exact to a millionth part.

See section on *Meanings of the Halls and Temples*.

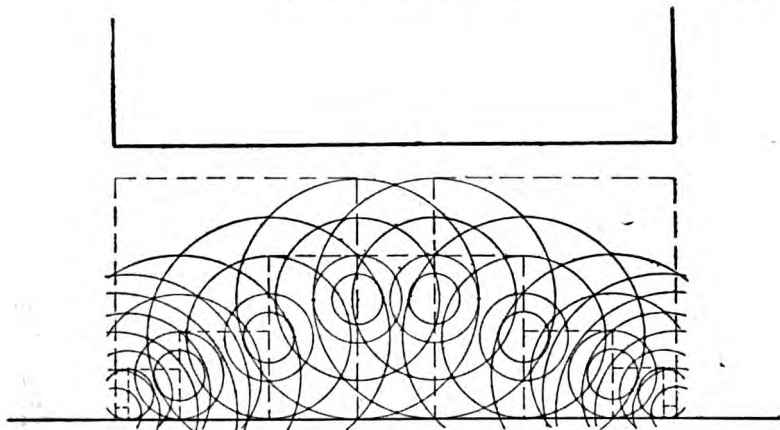

FIGURE 9

HALL OF UNITY AND THE FOUR WORLD WARS

The structure of this Hall of Unity—see circles in *Figure 9*—was designed to accord with Teleois proportions of 1, 4, 7, 13 and 19. 'Resolved' by the method used by ancient wise men, these become 1, 4, 7, 4, 1.

The Teleois proportions unified in this Hall symbolize not only action, but also perfection of unity in such action. This is the relation of 4 to 13. Hence any mathematical attempt to determine this Hall's time periods—with exactness to the fraction of a minute—will result in errors, *unless* it is recognized that the 13 designates a succession of lunar months in this Hall—approximately *thirteen* months to the year. Hence, in this Hall, the time unit is the lunar month of 28.0955 days, instead of the solar month of 30.4368 days.

This IS the Hall of UNITY. It is the symbol of the first world-united action in a common cause.

This Hall is also the symbol of a great *united spiritual advance* in man's evolution. Hence, it is NOT limited to the dates of the first great World War. Although that war united more than forty nations in unified action—some acting unselfishly—nevertheless, the war was *but one phase* of the new spiritual ideal of world union in action for the good of all.

The dates revealed are exact in accord with the intersections of the Teleois circles, shown by the black dots.

The forecast is definite.

There will be FOUR WORLD WARS.

Then permanent world peace!

We HAVE already HAD TWO of those wars; and at the date of this writing, the *third* World War has already begun!

The FIRST World War—1914 to 1918 inclusive—was fought NOT for democracy, but for *Power Dominance in Europe!*

For Beginning and Ending of Second World War, see *Meanings—Temple of Revelation and Temple of Initiation*; and *Figures 11 and 12*.

FIGURE 10
TEMPLE OF REVELATION

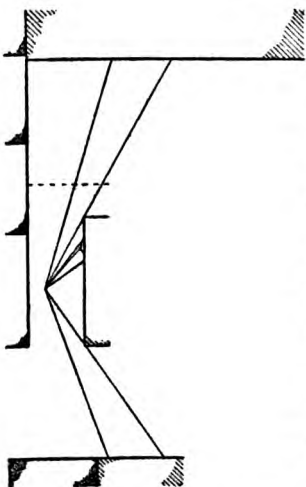

In Figure 10, only a few of the Vision Lines of the Temple of Revelation are shown.

The BOSS—the little projection on the upper right wall—is the same symbol which man sees in the Holy of Holies of the Temple of Temples in Thibet. And, from the point of vision of the human eye, it is seen at exactly the same angles as the one in Thibet is seen. And still more mysterious is the fact that the proportions of distances—from the eye to the Boss—are the SAME (1) in this Temple of the Great Pyramid, and (2) in the Temple in the Sacred City of Lhasa.

These three facts of vision lines to the Boss are found to have been the same in the Holy Chambers of the six great Temples of the past, and are designed to be built into the New Pyramid.

In length, this is the smallest temple of the Pyramid. In what it reveals, it surpasses all others.

It reveals: (1) the symbol of the Spirit of all Life; (2) the key designs of seven great temples of seven civilizations; (3) the perfected system of measurements used in the Pyramid; (4) three systems of numbers—including the decimal system—calculated to .00000001 parts; (5) the unification of decimal parts with Teleois proportionals; (6) the new mode of war—of the World War for Gold, more devastating even than the First World War; and (7) thirteen dates of events of the late movement of the holiest of the holy men of Lhasa, from Thibet to the high eastern Andes.

FIGURE 11

TEMPLE OF INITIATION

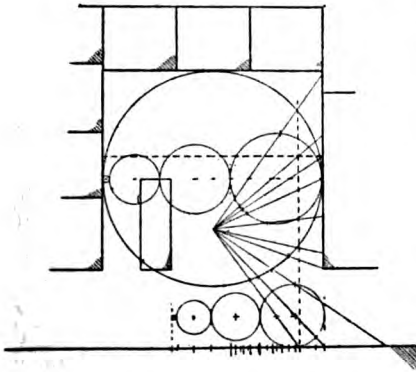

Figure 11 includes more than the Temple of Initiation. At left there is a small part of the Hall of Unity; then the Temple of Revelation and the Granite Leaf and the Hall of Adjustment underneath the Granite Leaf. The Temple of Initiation is the large space—at its bottom there is a series of smaller circles. At extreme right is the entrance to the Hall of Transforming Action, which man entered August 10, 1939. (In all sketches, each circle represents a *sphere* and each square represents a *cube*.)

The Sphere of the Days—the large circle, contacts both sides and ceiling. It includes with mathematical exactness the four perfect Teleois circles of 1, 7, 10 and 13 units respectively—the key proportions of this Temple. This is the Temple in which the builders revealed that they had discovered the square whose area equals the area of a circle whose circumference is 365.2422 units.

The time period of the Temple of Initiation extends from May 6 of 1931 to August 9 of 1939. During this time the Second World War—for the *Control of the World by Gold*—was ended. Also the Third World War, for World Dominance by territorial expansion, was begun.

The Second World War was the WAR for GOLD. *It was a war of aggression*, initiated in Europe in 1924. The aim was to gain absolute CONTROL of the WORLD by means of financial and consequently economic starvation of other peoples, so that—when loans were necessary for continued existence—military alliances could be forced on them! *In casualties this War for Gold was more terrible than the First World War!* (It is more vicious slowly to starve a man to death, than to kill him quickly by gun fire.)

This War for Gold wrecked the prosperity of the world; drove all great nations off the gold standard; threw sixty million people out of work; brought deprivation and misery to 300,000,000 people for 15 years. This caused such reaction, that the ideology of totalitarianism gained power. For end of this war, see Figure 12.

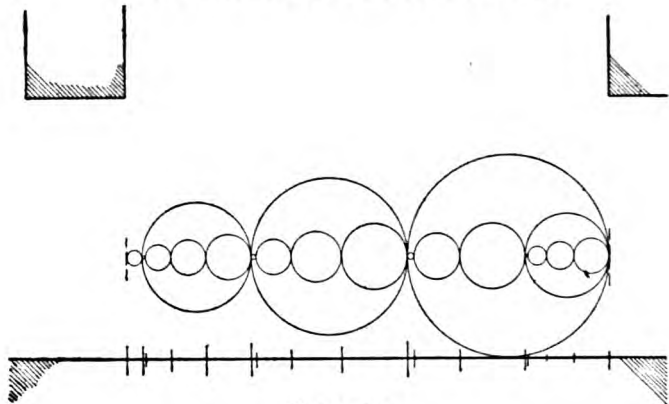

FIGURE 12

TIME CIRCLES—FLOOR LEVEL

Figure 12 represents the same series of circles as shown at the bottom of Figure 11.

This additional drawing is given here to indicate the perfection of the smaller Teleois circles, occurring within the larger Teleois circles. In any one Hall or Temple, these are always the same. But each Hall or Temple has a definite series of proportions of its own.

The proportions of size of these circles are not determined by personal opinions or ideas.

They are the SAME Teleois proportions which determine the structure of the Pyramid; they are the same proportions as are found in our musical scale, and in measurements of the lengths of every predominant part of the human skeleton, in every beautiful geometric design, in the designs inside of tiny snowflakes, and they are the only known approximate proportionals of distances from the sun to its planets.

The circles in this Temple, by their dominant intersections, define the end of the Second World War and the beginnings of the Third World War.

The Second World War—*Hidden and Secret*—the War for the World Control by Gold, was a war of aggression (See Comment, Figure 9), and its devastation was greater than that of the First World War of 1914–1918 (See Comment, Figure 11).

Its success seemed certain, until the last battle—that against the United States!

The *coup de guerre*, which turned the tide of success to defeat, was initiated by a midnight decision at Campobello. The bomb which ended the War of the Greed of Gold was dropped in 1933, by a special envoy sent to London by the then President of the United States. The war was won by the United States for the good of the world.

The Third World War began in Manchukuo in September 1931 and in Ethiopia in December of 1934 and in Europe on September 1, 1939! This is the *War for World Dominion by Territorial Expansion!*

The FOURTH World War for Permanent World Peace will follow the Third World War; it will be fought to win World Peace before March 6, 1947.

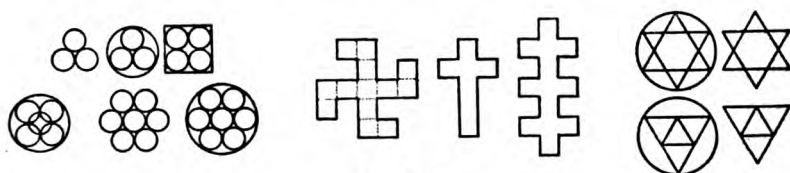

FIGURE A

TELEOIS GEOMETRICS

Geometric designs have been used in thousands of stained glass windows, and on tens of millions of charms, vases and *objets d'art*. As sacred symbols, they appear in the churches and tombs and temples of all ages and of all civilizations.

Such designs are composed of the spaces of triangles, squares or circles, and the spaces in *between* the triangles, squares or circles. Without these intervening spaces, the designs would not exist. So in counting the number of spaces of any geometric design, *all* spaces are counted.

There are four extraordinary facts of these geometric designs.

First, with many hundreds of numbers from which to choose, *only seven* groupings of geometric spaces have been widely used for designs.

Second, the simple Teleois numbers are 4, 7, 13, 16, and 19.

Third, *every* geometric design used through the ages, is a group of Teleois numbered spaces.

Fourth, *every sacred or mystic geometric symbol* is also a design of Teleois spaces or proportions.

Fifth, these Teleois spaces form the only geometric designs which have been considered beautiful in all ages and by all peoples.

Sixth, Teleois numbers and proportions appear to be the basis of all perfect form on earth, and even of distances beyond the earth! In fact, in the solar system, the respective distances from the sun to its planets and asteroids are Teleois proportionals. They are more exact than the proportions determined by Bode's law.

Seventh, Teleois proportions determine the structure of *all* the Halls and Temples of the Great Pyramid of Gizeh.

Other facts of the Teleois and its use in the Great Pyramid are given in the text and in other figures.

FIGURE B
OIL LAMP 'IN' SNOWFLAKE

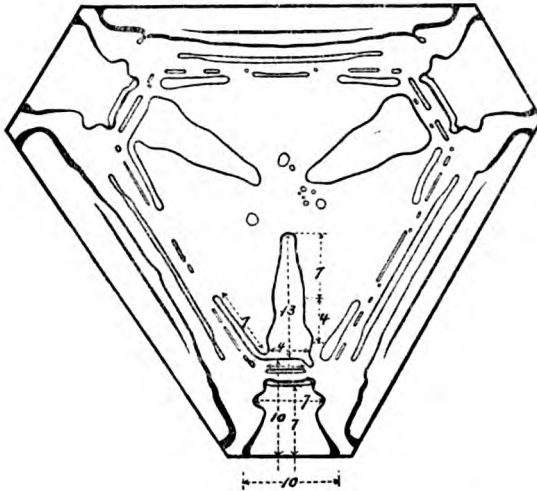

During forty years, scientists have made photographs of several thousand snowflakes. Very large enlargements of these make it possible to measure distances inside the snowflakes, exact to $1/100$ of a millimeter.

Man marvels as he examines scores of these photographs. What he sees is not due to imagination, for cameras have no imagination.

The photographs prove that many of these snowflakes—formed high up in

the sky—contain designs of many of the actual things which man himself has made here on earth! A hundred or more show designs of cuff buttons, sherbet glasses, finger bowls, lamps, rolling pins, crosses, daggers, flat irons, hand mirrors, anvils, fences, oil cans, ink wells, et cetera.

Dimensions of these designs are in Teleois proportions. Note the crude design discovered in one snowflake—of an old-fashioned oil lamp with a handle. Its measurements are 4 to 7, 7 to 10, 10 to 13.

These SAME proportions determine the marvelous beauty of the Taj Mahal; and they are found also in distances in the solar system; and in all major structural features of the Great Pyramid.

There are only three basic Teleois numbers. They are 1, 4, and 7—one, four, seven.

Other numbers are Teleois and there is a simple way of testing them. When the sum of the digits of a number is 1, or 4, or 7—it IS a Teleois number. No other numbers are Teleois. For example, 13 is Teleois. Its 1 added to its 3 is four, and 4 is a basal Teleois. So also 25 is Teleois. Its 2 added to its 5 is seven, and 7 is a basal Teleois. And 31 is Teleois. BUT 27 is NOT Teleois. Its 2 plus 7 is nine, and 9 is NOT a basal Teleois.

Please note: the fact that the addition of the digits of a number gives 1, or 4, or 7, is NOT the reason WHY that number is Teleois. It merely happens that this addition is an arithmetical means which can be used as a test.

FIGURE C
TELEOIS PATHS OF COMETS

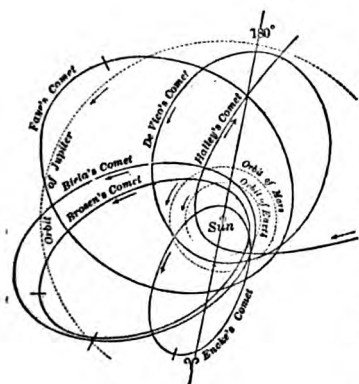

This *Figure C*—after Russell-Dugan-Stewart—illustrates the *paths* of some of the major comets which astronomers have studied during the last century and a half.

The data which follow do NOT represent units of measure. They represent proportional distances. Data given here do not show the relation of the path of one comet to that of another.

Instead, each group of two figures given below—such as 7 to 13—represents only the width and length of the path of one comet,—that is, the *proportional relation* of its diametric width of path from side to side, TO the path's length from end to end.

The width to length of the path of Encke's comet is the same as the proportion of 7 to 13; that of DeVico's, the same as 13 to 16; that of Brosen's, 16 to 25; of Faye's, 16 to 19; of Biela's, 19 to 31.

All are Teleois proportions.

When one finds these Teleois proportions in the solar system, in the human skeleton, in every geometric design which has been considered beautiful in all ages, in intervals of the musical scales, in the structure of every building of great beauty, and in the designs found inside of snowflakes, it suggests that there is some basic proportional principle of creation.

The exactness of Teleois proportions in Pyramid structure may be illustrated—for example—by the height and length of the Hall of Transforming Action.

Remember that 13 and 31 are Teleois numbers.

The height of the Hall of Transforming Action is 42.368807 Pyramid inches.

Its length is 101.033309 Pyramid inches.

That height to that length is as 13 is to 31—exact even to 1/1,000,000 part of an inch!

FIGURE D

PERFECTION OF SKELETAL STRUCTURE

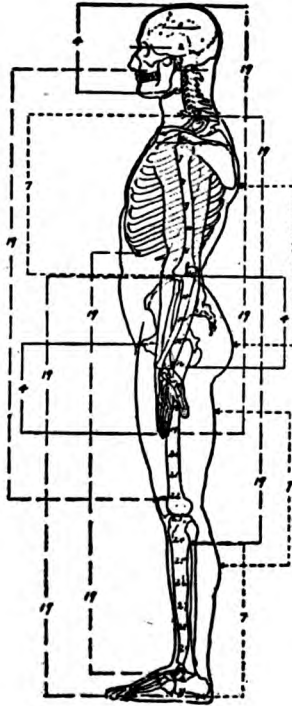

Figure D shows only 12 of the Teleois proportional lengths of parts of the human skeleton.

There are 121 other lengths of Teleois proportions in the human skeleton. The reason only 12 are here shown is that, if more were drawn into the sketch, the illustration would be confusing.

These Teleois proportional lengths of parts of the human skeleton were determined from designs which were made mathematically exact to a millimeter, to accord with data of measurements of typical skeletons at Harvard, Cambridge and Oxford Universities—the skeletons being measured to 1/10,000 part of an inch.

These data were checked with averages of 10,000 body measurements made by the late Dr. Dudley Sargent of Harvard, and with averages of the 40,000 measurements made by de Giovanni of the University of Padua, Italy.

EACH length of any predominant part or section of the human skeleton IS in Teleois proportion to every other important part or section.

There are variations *only* in lengths of arm and hand, and lower leg and foot, probably due to the fact that particular activities or conditions under which humans lived for ages, modified lengths of these parts.

It is almost weird, to realize that the same Teleois proportions found in the human body determine the beauty of a Duncan Phyfe chair, indicate the respective mass weights of planets, and correspond to the proportions of dimensions of every beautiful cup or vase or piece of sculpture of Greek art.

All beautiful geometric designs are in Teleois parts; the respective distances of planets from the sun are Teleois; and time periods and symbolism of the Great Pyramid are in terms of Teleois proportions.

FIGURE E
SOLAR SYSTEM

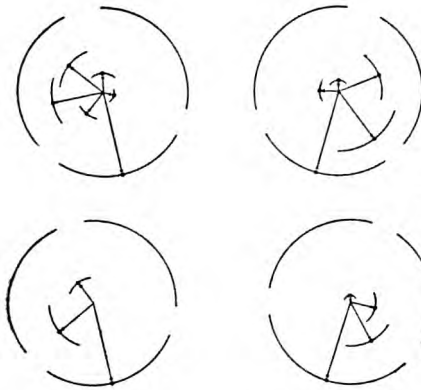

From the sun outward, our solar system includes (1) minor planets, (2) asteroids, and (3) major planets.

In *Figure E* one cannot—on a page of this size—represent actual distances as different as 36 and 3525. So proportionals in each design apply to that *one* design only.

UPPER LEFT: Approximate proportional distances¹ of minor planets and first and mid-asteroids are, respectively, 4, 7, 10, 16, 19 and 31 Teleois units, from the sun.

UPPER RIGHT: Approximate proportional distances¹ of major planets are, respectively, 4, 7, 16, 22 and 31 Teleois units, from the sun.

LOWER LEFT: Approximate proportional asteroid band distances, from last minor to first major planet—are respectively 4, 7, 13 Teleois units, from the sun.

LOWER RIGHT: There are also approximate proportional distances from second nearest minor, to second nearest major planet, which are respectively 1, 4, 7, 13 Teleois units, from the sun.

Ancient wise men gave meanings to these Teleois numbers. They used them—as in the Pyramid—to symbolize knowledge, time periods and even dates.

They used these numbers in the same way that we use \$, Pi, ?, I, et cetera.

Our signs would have been meaningless to them, until they learned what we meant by them.

So also their 'number symbols' are meaningless to us, *until* we learn what they used them to mean.

¹ All these proportions are approximate, because of eccentricities of orbits; yet they are nearer the actual solar system distances than the proportions obtained by Bode's Law.

Generated at University of Chicago on 2022-03-19 18:47 GMT / https://hdl.handle.net/2027/duug.30112080012150
Public Domain in the United States; Google-digitized / http://www.hathitrust.org/access_use#pd-us-google

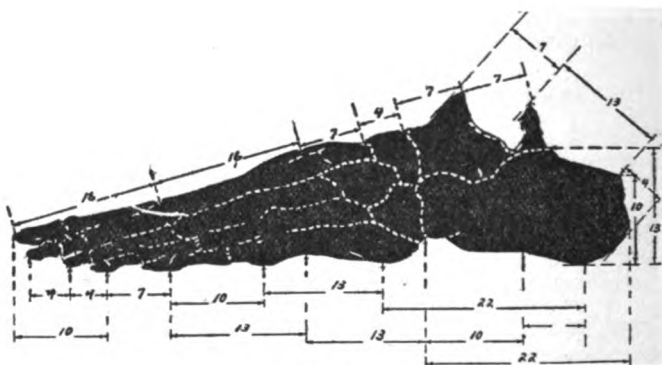

FIGURE F

ANKLE AND FOOT

Anyone who even casually examines the bones of the human ankle and foot is impressed by the irregular forms of the bones, and the seeming lack of any recognizable proportion of the length of any one bone to that of any other bone. No other part of the human skeleton is composed of bones so irregular in form.

Yet, when one studies photographs taken from the top of the foot—or from the bottom, or from either side, or from a point diagonally above in front, or diagonally above from behind—one finds that every predominant length of part or section is in Teleois proportion to lengths of other skeletal parts of sections.

For method of determining exactness of such proportional lengths, see Comment to *Figure D*.

The Teleois proportions of the ankle fall into units of 4, 7, 10, 13, 16 and 22.

Why are the ankle and foot adjustable and strong, and why can a bridge stand exceptional strain when built on the basis of Teleois lengths of parts? Why are the parts of a design inside of a snowflake, and the distances of planets from the sun, in the same Teleois proportions? Why are the beautiful intervals in musical scales and the form of the most beautiful building on earth, determined by Teleois proportions?

Why was the tiniest piece of exquisite gold workmanship on earth tooled to 7 sides? And why is the great building stone of more than 150 tons used by the ancient Tiahuanacans, cut so that it has 34 sides—the 4th perfection of 7?

WHY are time periods and dates in the Great Pyramid, and its symbolism and its very structure, all in accord with Teleois proportions?

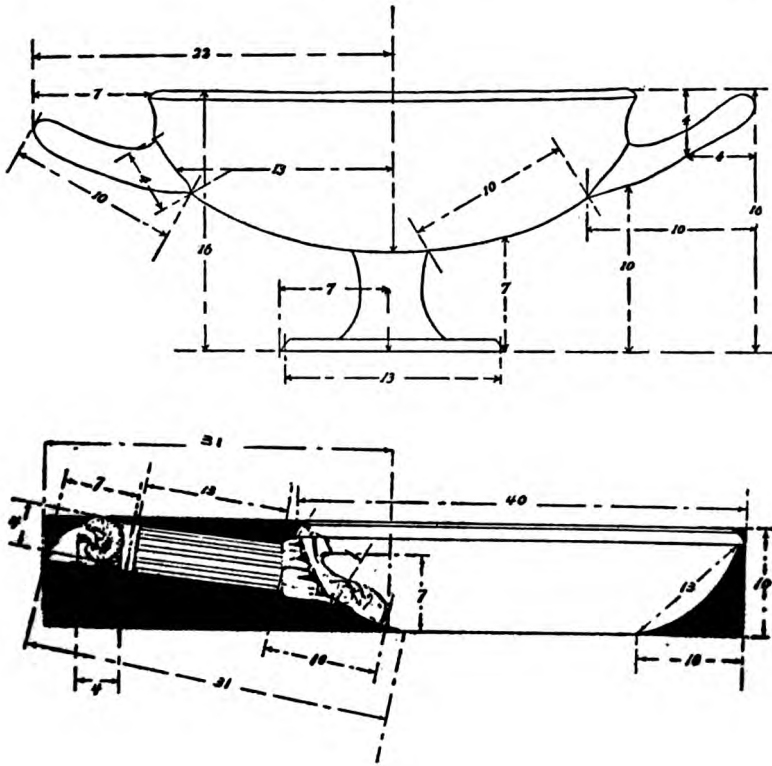

FIGURE G

TELEOIS PERFECTION IN ART

Hambidge directions: "Total length is 4.270. This divided by .691 equals 6.18. Side elevation . . . with handle, is an area composed of 10 whirling square rectangles. Length of handle is 2.073. Side portion of handle shows a rectangle of 3 squares. Ground plan of bowl is 4 x 4; ground plan of handle and attachments is 3 x 4. The ratio 1.545 is equal to .681 multiplied by $2\frac{1}{2}$ or 1.236 plus .309. Side elevation is .691 and length .4270, the ratio 6.18, or ten whirling square rectangles. The reciprocal of 1.545, the ratio of the overall plan, is .6472. This divided by 4, equals .1618 or ten whirling square rectangles. The height, .691, divided into 1.506 plus, equals 2.180, or .545 multiplied by 4."

NOW, COMPARE the simplicity and perfection of the Teleois system of proportions. To design this same pan or patera, all you need to use are dimensions in the proportions of 4, 7, 10, 13, 31 and 40. The use is very simple; the result, perfect.

MIRACLE WORKERS

by Brown Landone

In some lines of science, greater and more important new discoveries have been made in the last seven years than in all the preceding seven thousand years.

One is HOW to use, simply and practically, the sources of mysterious energies which can act as *miracle workers* in the body.

These miracle workers are contained in certain CATALYTIC or 'WORKER' foods. There are foods you seldom eat, which contain enzymes that amazingly multiply the activity of certain physiological processes. And foods containing aminos—mysterious substances out of which the mystic hormones are built.

We now know that it is lack of catalytic or 'worker' foods, which lets us age so rapidly and die so young, even when using all the vitamins and the best natural foods grown in sunshine.

But this need no longer be! Use of newly discovered knowledge makes it possible for you to transform not only your body but your very life—renewing ENERGY, maintaining and augmenting your consciousness of VITALITY, VIRILITY and YOUTHFULNESS.

MYSTERIOUS CATALYTIC FOODS

There IS something newly discovered! And something newly written! It tells of the miraculous CATALYTIC foods!

Much is known of common foods. But they are NOT life-giving, because no matter how wisely you choose such foods, you begin dying even before you are 24 years old! Even with all the vitamins and foods of sun-energy, you will continue slowly dying all the rest of your life!

It is tragic to grow old rapidly, and it is NOT natural; there is NO need of it. Animals live five to seven times their maturity. Why shouldn't you? Even a wild goose often lives three times as long as you do!

But NOW, with the new discoveries, your life may be changed to a new feeling of youthfulness and virility.

It is the INNER foods that are all important; lack a certain hormone, and a person sinks into idiocy; increase it, and he is brilliantly intelligent. Lack another, and a person is a washout as a personality; increase it, and the same person is vivacious, entertaining, witty. A little lack of another and one lacks height; add a little and height is increased even in an adolescent. Also weight goes up and down in accord with the balance of hormones.

Then also, a man is an inner coward or a courageous hero, according to the absence or presence of another hormone. The condition of the skin—youthful or old and wrinkled and darkened—depends on the innerfoods. Your energy, strength, vitality and virility—all depend on hormones.

A chemical catalyst can increase energy and activity 1,000 times without using up any of its own energy. It multiplies energy amazingly. Just so do similar catalytic substances in your body work with astounding energy and power when activated by the right foods.

THE SECRET OF YOUTH!

Send for new booklet "The Secret of Youth". It tells about the Mysterious Catalytic Foods, shows you how they work to invigorate the glands.

THE BOOK OF GOLD

152 West 42nd Street

New York, N. Y.

BE RICH!

*Here Is a Law of Increase
That Was Used by the Prophets of Old*

Here is a secret of success that has been buried 1,900 years deep. Here is an "Open, Sesame!" to riches such as has not been known since Aladdin's fabled Genii of the Lamp.

It was known to and used by Prophets and Seers of ancient days. It was re-discovered by Jesus, and was the basis of every miracle of increase that He performed. It opens a new Kingdom to you, a Kingdom where you can win dominion over every adverse circumstance.

"Seek ye first the Kingdom of Heaven . . ." Jesus bade us, "and all things else shall be added unto you."

What is "Heaven"? Where is it? The word used for "Heaven" in the original Greek text is "Ouranos", and Ouranos means EXPANSION. This is further borne out by Jesus' description of it. "The Kingdom of Heaven is like to a grain of mustard seed, which a man took, and sowed in his fields; which indeed is the least of all seeds, but when it is grown, it is the greatest among herbs, and becometh a tree, so that the birds of the air come and lodge in the branches thereof. The Kingdom of Heaven is like unto leaven, which a woman took and hid in three measures of meal, until the whole was leavened."

So the Kingdom of Heaven would seem to be the Kingdom of EXPANSION, the place where you can increase and multiply the good things of life, just as Jesus increased the loaves and fishes, or filled the disciples' nets to bursting after they had labored all night and caught nothing.

How to find this Kingdom of Expansion, how to learn the "Open, Sesame!" that opens its gates to you, and the way to use its amazing power of increase, are clearly and simply set forth in a little book called "The Kingdom of Expansion", by Robert Collier.

Send for it. A post card will bring you a copy, without cost and without obligation. Just say—"Send me by mail, *postpaid*, a FREE copy of THE KINGDOM OF EXPANSION."

THE BOOK OF GOLD

152 West 42nd Street

New York, N. Y.