

The Journal of Borderland Research

TABLE OF CONTENTS

BE SURE YOUR DOCTOR IS HONEST, Part I Dr. Mendelsohn Interview	1 - 6
USE OF CRYSTALS IN HEALING Interview With Oh-Shinnah	7 - 10
CATHOLICS IN A QUANDARY, Pope or Reagan? By John Dart, LA Times.	11 - 15
TENS, THE ELECTRONIC WAY TO STOP PAIN Adapted From "Changing Times"	16 - 20
CLIPS, QUOTES & COMMENTS Those Cavern World Connections, Meeting The Earth Gods Face To Face, Masters Of Humbug and Deceit, What Says The Master?, Discord Means Eventual Disintegration, A Professional Discord Sower and Military Gangster Confesses, The Dilemma Of The Falklands, Voice Of Re- search and Prophecy From Down Under, Another Prophet Heard From On Fateful 1984, The Plan- ned Military Takeover, The Monad "Magnapulse" ELF Wave Device, Skilling's TENS Body Pulse Unit, Radio Shack's Economy ELF Wave Metronome, Need Something Electronic?, By All Means, Professor, Spread The Borderland Word, The AF Keeps In Practice For 1984, and Borderland Sciences Research Foundation Lit.	21 - 36

THE JOURNAL OF BORDERLAND RESEARCH

BSRF No. 1 Published by Borderland Sciences Research Foundation,
PO Box 549, Vista, California 92083 USA. Edited by
the Director, Riley Hansard Crabb, MsD.

The Journal is published six issues a year with the assistance of the Associates, at the Director's home, 1103 Bobolink Drive, Vista. It is printed, 36 pages an issue. The Foundation is incorporated under California law, May 21, 1951, #254263, and has been in continuous existence since then. Correspondence is addressed to the PO Box. The Journal is included in the Foundation membership of \$12.00 a year, domestic. Foreign membership/subscriptions are now \$15.00. Single copies and back issues of the Journal are \$2.50. A donation of \$12 domestic or \$16 foreign will also bring the Journal to those who don't care to join BSRF. The Director's wife, Mrs. Judith Crabb, is office manager and Secretary-Treasurer.

PURPOSES OF BSRF: This is a non-profit organization of people who take an active interest in unusual happenings along the borderland between the visible and invisible worlds. In the words of the late Meade Layne, founder and director of BSRF from 1946 to 1959: "BSRA publications are scientific in approach but employ few technical expressions. They deal with significant phenomena which orthodox science cannot or will not investigate. For example: The Fortean falls of objects from the sky. Teleportation, Radiesthesia, PK Effects, Underground Races, Mysterious Disappearances, Occult and Psychic Phenomena, Photography of the Invisible, Nature of the Ethers and the problem of the Aeroforms (Flying Saucers). In 1946 BSRA obtained an interpretation of the phenomena which has come to be known as the Etheric or 4-D interpretation; it has not been radically altered since that time. This continues to be the only explanation of the UFOs which makes good science, sound metaphysics and common sense."

The chief present concern of the Foundation is to make this kind of unusual information available as a public service at reasonable cost. Headquarters acts as a receiving, coordinating and distributing center. An important part of the Director's work is to give recognition, understanding and encouragement to people who are having unusual experiences of the borderland type and/or are conducting research in any of the above fields. For consultation on borderland problems or for Spiritual healing through prayer, write or phone 714-724-2043 for help or for an appointment. Donations and bequests toward Foundation research programs and expenses are welcome.

The 35-page list of BSRF publications is available from Headquarters for \$2.00 in money, check or stamps. This includes brochures on borderland subjects, tape recordings of Crabb's lectures and of members of the Inner Circle, talking through trance-medium Mark Probert. Write to BSRF, PO Box 549, Vista, California 92083 USA.

BE SURE YOUR DOCTOR IS HONEST, SAYS DR. MENDELSON

By Ron Kotulak

From the NHF's "Public Scrutiny", March 1981

PSA: In your book "Confessions of a Medical Heretic" you said that physical examinations were basically worthless. But aren't regular checkups such as those for the Pap test and hypertensive screening effective in detecting early problems that can be treated?

MEND: Let me give you my reference. British researchers found no change in the incidence of cancer of the cervix or in the mortality rate in those areas of England which have extensively used the Pap test, and in those areas which haven't used it at all. Now, I think the reason for that probably goes something like this: Since the Pap smear has false positives and false negatives, some of the people who are mistakenly diagnosed as having cancer of the cervix then get into trouble from overtreatment. My argument is that the Pap smear ends up saving some lives and killing others. Or, if you want to put it a different way, it's still a controversial item in medicine and shouldn't be accepted as gospel.

PSA: What about catching early hypertension?

MEND: My problem with hypertension is that the definition has changed. In 1971 the U.S. Public Health Service definition of hypertension was anything higher than 165 over 95. By 1977 it changed to anything higher than 140 over 90, thus making 13 million more persons eligible for antihypertension drugs.

My concern is that hypertensive drugs have so many adverse effects that now we are giving them to people we never prescribed them for before, the benefits are outweighed by the risks. You see -- my argument is that doctors are always manipulating the limits of normality to fit their own biases.

PSA: Wasn't there a VA study a while back that showed that even treatment of a mild hypertension resulted in fewer strokes?

MEND: Yes, and that's the reason they changed the definition. But that was a single study and far from conclusive. So again my answer



MENDELSON

is that that this is all controversial and therefore should be reported as such, rather than as dogma.

WHEN SHOULD ONE SEE A DOCTOR?

PSA: Well, if people are to abandon physical exams altogether, when should they see a doctor?

MEND: I think there are a few things they should do. Number one, they should see a doctor when they have symptoms.

PSA: Such as?

MEND: Let me put it this way: The best part of American medicine is emergency medicine. So when you have emergency symptoms -- acute appendicitis, kidney stones, hemorrhage or broken bones -- then there's no question about it. That's where the benefits outweigh the risks.

Now, if you have mild symptoms or symptoms of a chronic nature, that's where you can get into trouble with modern medicine. This is why I maintain that people have to look to other methods of keeping healthy and other methods of treating disease. For example, if you have high blood pressure, you've got to look for something other than drugs.

PSA: Meaning diet control and exercise?

MEND: Yes, and since American doctors know nothing about nutrition, you cannot look to them for advice. Almost all their nutritional advice is either wrong or outmoded.

PSA: Should a person even have a doctor to begin with?

MEND: I would say it is not necessary because I assign to the doctor the role of lifeguard, and as you know, most people on the beach don't have their own personal lifeguard.

PSA: In the event somebody develops a symptom he's worried about, how does he then go about selecting a doctor?

MEND: Let me start at the beginning of life and go right through. If a woman is looking for an obstetrician, she should look for someone who has a low caesarian section rate, say 6% or 7%. And if she's selecting a pediatrician, she should look for someone who will share with her the dangers of bottle-feeding, and will also tell her the dangers as well as the benefits of immunizations. If you're looking for an internist or a general practitioner, you should look for someone who will give you information about the adverse reactions to the drugs being prescribed. And if you're looking for a surgeon, then I think you should ask a whole bunch of questions about what his success rates are, what his failures are. Just like a baseball team, I would love to see surgeons' records published like hits, runs and errors.

PSA: Are you saying basically that you should see a doctor who will share information with you?

MEND: Yes. You should see a doctor who will be honest. I would say that if nothing else, that would be the single most important thing.

PSA: How should a person select a hospital and when should he go into one?

HOSPITALS DONT TREAT PATIENTS

MEND: He should never select a hospital, because hospitals dont treat patients and they should not treat patients. And if he selects the right kind of doctor, that doctor will protect him against hospitalization. Let me go back a step. You should select a doctor whose temple is the home and not the hospital. For example, I commend for general practitioners doctors who still make house calls.

PSA: You call drugs a sacred ritual that is often misused, but aren't some medications necessary, such as those for high blood pressure?

MEND: Yes, for malignant hypertension, which is 1% of all the cases of hypertension, drugs are invaluable. For Addison's disease, cortisone is lifesaving; penicillin for meningococcal meningitis. I am by no means a nihilist. I just think that the extremes have become the mean, and that we're using drugs and surgery in cases where they were never meant to be used.

PSA: What proportion of drugs would you say are being needlessly prescribed?

MEND: I would say more than 90%, because the major categories of tranquilizers are almost all not just useless, they are absolutely hazardous! Anithypertensives, antiarthritics, behavior modifiers in children (ritalin, dexedrine and others like them) are almost always incorrectly prescribed. It wasn't so bad when medicine was restricted to the rich; but now with medical insurance covering the middle class and the poor, that means everybody gets the same dangerous kind of care that once only rich people could get.

PSA: Many doctors, parents and schoolteachers swear by the use of amphetamines for controlling hyperactivity in children. Are you against this form of treatment?

MEND: Yes. There is no question that it works, but I think it's basically irrational treatment because of some of the side effects already known: growth retardation, for example. And there are other studies that question its efficacy. There is absolutely no information on long-range side effects.

PSA: What can a person do to determine whether or not a drug is being properly prescribed or whether or not he should take it?

MEND: He can do certain things himself. Before he gets the prescription filled, he can stop off at the public library and spend 20 minutes reading up on the drug. And he wont have to do that if the FDA legislation gets passed mandating package inserts for

every drug, not just The Pill. The second step is to talk about the drug and your disease with lots of other people. Discuss it with relatives, friends, clergymen and associates -- do all the things the doctor is telling you not to do.

HOW MANY DOCTORS MONITOR DRUGS?

To me, one of the most important parts of prescription information is the rules for monitoring the drug. If you take a look at most of these drugs, there are extensive recommendations. For example, for the major tranquilizers, they recommend frequent ophthalmological examinations to detect formation of cataracts. The same thing for cortisone. And you how many doctors monitor drugs? If you prescribe diuretics, you're supposed to monitor the electrolytes to make sure you're not getting low potassium levels. So what do doctors do? They tell you to eat bananas instead of monitoring the levels.

My feeling is that if drugs were prescribed correctly, if doctors really followed the books and the manufacturer's directions, we wouldn't be in this mess today. But that would take a lot of time with each patient, because you can't do that in a hurry.

PSA: Recent government reports on unnecessary surgery state that 2.4 million unnecessary operations are performed each year, leading to a waste of \$4 billion and 12,000 unnecessary deaths. These estimates have been criticized by a lot of people as being inaccurate.

MEND: The American College of Surgeons said that a little more than 10% of surgery was necessary. I couldn't get over that. Even surgeons now are jumping on the bandwagon.

PSA: But isn't it stretching it a bit far to say that 90% of all surgery is unnecessary?

MEND: Well, let's take a look at the most common operations. The most common operation in this country is vasectomy -- over a million a year. And it's performed without informing the patient of the already-known risks, such as changes in the blood enzyme.

The second most common operation performed is circumcision on the first day of life. Nobody is ever told the risks of "routine" circumcision. There's at least another million, that makes two million.

Then there's 800,000 hysterectomies, and nobody's ever told about depression following hysterectomy. Tonsils are still being operated on at the rate of about 700,000 a year. So that gives you somewhere over 3.5 million unnecessary operations, and that's without getting into cancer surgery.

AH, YES, THE HIGHLY PROFITABLE MASTECTOMY

Dr. Mendelsohn doesn't get into cancer surgery in this interview but we have an excellent example of what he had in mind from Dr. X's best seller, "Intern", a Fawcett paperback, New York, 1968.

". . . With all these accounts of breast cancer I haven't mentioned what the surgeon tells these patients before surgery or after. Mrs. DuPre is a good case in point. Dr. Peterson had found a lump in her breast on a routine physical exam. He sent her over to Slater, who thought it was probably malignant, from its appearance. He urged her to come into the hospital as soon as he could get her scheduled for a breast biopsy; she was actually operated on three days after the lump was found.

"Of course Slater didn't tell her he was sure it was malignant. He just said that any time something like that appeared, it was almost always benign, but it should be removed and examined because of the remote possibility that it might conceivably have an early cancer in it, and he didn't dare to take any chances with a thing like this. He described what the biopsy would be -- just a small incision, an overnight stay in the hospital, etc. -- but said that if it should turn out to be malignant, they would know it right then and there while she was in surgery (and totally unconscious and non-resistant), and in that case he would want to be free to go ahead and remove the whole breast right then, since in a case like that he wouldn't want to even lose a day in getting rid of it for her (and lose his fee for the surgery).

"Mrs. DuPre had agreed to this, reluctantly. I guess some do and some don't. Some have to think about it for awhile or want a second opinion, and this is perfectly okay, but in such cases the surgeon leans a little more heavily on the possibility that the lump might be cancer, because it is quite literally true that every day counts and you cannot guess what day is the day the thing first starts to spread. Then during surgery, if the frozen section shows cancer, you not only remove the breast but try to determine whether it has spread or not by examining nodes from under the arm and between the ribs and even inside the rib cage by frozen section. That determines whether to recommend X-ray therapy after the surgery, or hormone therapy, or what.

MUTILATED FOR A "SCIENTIFIC" SCAM

"Of course, it's a shock under these circumstances for a woman to wake up after a hopefully minor biopsy and find a breast gone from armpit to navel, but apparently if you bear down too heavily on this possibility, you scare away some who might be cured and keep them scared away until there's no hope at all, so it is a kid-glove business.

"Mrs. DuPre was terrifically distressed and frightened when she woke up, and I wondered what Slater would say to her the first time he saw her after surgery. I found out on rounds with him the next morning, and I can't imagine any more kind and thoughtful thing than what he did. He walked into her room just beaming from ear to ear, and shook her hand like a long lost friend, and looked her straight in the eye and said, 'Madeleine, congratulations! We found a tumor there, but we found it in time and removed it completely, and you are cured!' No equivocation, ifs and or buts.

"Afterward Slater said that half the time he knows he is lying, but he thinks this is very important to tell the patient, whether there was any evidence of spread or not, not only because of the physical and psychological blow of finding the breast gone, but because having an incurable cancer is the one thing these women are really afraid of, and the only way you can relieve them of that fear is to tell them point blank that they are cured and make them believe it. Later, when they're back on their feet, is time enough to explain that it may take time to find out for sure whether they are cured or not; tell them that to start with and you just torture them when they have nothing to fight back with." (Intern, pp 200-201) Now back to the Dr. Mendelsohn interview, from "Public Scrutiny":

ELIMINATE THE PEDIATRICIANS?

PSA: You come down pretty hard on pediatricians, saying that this segment of the medical profession perhaps should be eliminated. Yet isn't that your profession, doctor? How can young parents be expected to have the know-how and confidence to treat all the maladies of childhood?

MEND: Remember my phrase in the book about one grandmother being worth two pediatricians? Well, I tell people who want advice to go to people who have successfully raised children. My favorite organization these days is the La Leche League. Or any of the homebirth movements. I would go to them for advice and stay away from doctors, particularly if you want to nurse your baby.

Pediatricians are death on nursing even though they pay lip service to it. They'll think of any reason to tell a mother to stop nursing, and yet they don't know anything about it. They separate the baby from the mother at birth and destroy the opportunity to breastfeed. (Not to mention that all-important electro-magnetic, skin-to-skin contact between mother and child! RHC)

Also, pediatricians have never complained about obstetric excesses. It's almost like the Germans who knew what was happening (to the Jews), because the pediatricians knew that the obstetricians who gave analgesia and anesthesia were endangering the health of the babies, and they've known that since I've been in pediatrics, since 1940. No pediatrician has ever criticized an obstetrician, because if he does, he's out of business. Just stay away from the pediatrician who looks benign and compassionate because he's the most dangerous kind.

PSA: Why is that?

MEND: Because he will seduce you into doing the wrong thing. You know, you can always trust an SOB because you know where he stands. If you've got a pediatrician who says, 'Breast-feeding is for the cows,' then you know where he stands. But if you've got a nice pediatrician who says, 'I'm all for breast-feeding,' and then as soon as your child shows a little jaundice, he tells you to go off breast milk, he is operating under the cloak of love, much like the Spanish Inquisition did. (Continued in the next Journal)

OH-SHINNAH
ON THE USE OF CRYSTALS IN HEALING

From "Expansion", July-Aug 1981

By Caroline Myss

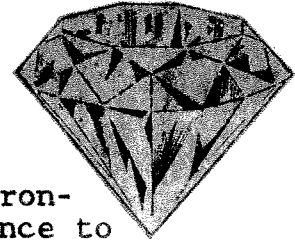

Oh-Shinnah -- a woman small in stature, powerful in spirit -- says of herself, "I prefer to be known as one with no history and as a confrontation to fixed reality. We attach such importance to things like data, personal credentials. We get all caught up in that and never see the person. My blood is primarily Indian. My heart is of the earth. I believe that knowledge and wisdom stand on their own volition."

And indeed, knowledge and wisdom seem to guide the abilities and thoughts of this woman, who is a trained psychologist, a native American, a healer and a leading expert in the art of working with crystals. Oh-Shinnah uses her knowledge of crystals in her work as a healer and it has earned her the respect of the scientific and medical communities.

"All of my work areas promote healing and not necessarily in the healing of the body. Sometimes healing is allowing the body to cease and desist and allowing the spirit to go on," Oh-Shinnah said. "And I work with healing the planet because I really don't believe there is healing on any level until the planet itself is healed. What we are as human beings is reflected in our environment and we are polluted."

Oh-Shinnah acquired her knowledge of crystals from, as she described it, two sides of the road. "My primary learning was from my great grandmother who was a Mohawk, and my father who is a full blooded Apache. I grew up with it. My great grandmother gave me hers when she crossed over. I was 18. She said I could keep the crystal and that it was my key to get back and forth between her in this world and in the next. Crystals are magic. They really are. They'll come to you when its time for you to have them.

"I've learned about crystals from the Mayans, from the Navajo and from a Tibetan teacher. Apache people have always used them. Almost all native peoples everywhere in the world have used crystals. I wondered why and I started researching it. There is all sorts of scientific data that covers what is going on with crystals in the physical realm.

"I believe that today's mysticism is tomorrow's science, and

what we're doing linguistically is catching up to what is being done on spiritual levels. We already live in a crystal technology. The major component of watches now is a crystal and in computers, the crystal is the memory bank. So that indicates to me that what my great grandmother told me about being able to charge them -- to program them -- makes absolute sense. I can take a crystal and I can breathe my intentionality into it and program it to do a certain work for me.

THE BODY IS A LIQUID CRYSTAL

"And the body, being 78 to 96% water, is a liquid crystal. If you examine the skin with a microscope, you will see little crystals, not to mention the blood and urine crystals," Oh-Shinnah stated.

"A small crystal set next to a very large crystal will come up and duplicate the electromagnetic vibration of the larger crystal. When you put a crystal on, it elevates all the little body crystals and they will duplicate the vibration of the larger crystal, or the one you're wearing. And coupling with your own electromagnetic field, the crystal increases your field energy in front of you. It's like a vortex of energy. They also have a refractive index. They push energy away."

Oh-Shinnah emphasized that the most important point to remember about crystals is that they magnify intention. "I work primarily with quartz crystals. Clarity is very important in a crystal and you don't want to work with a real tiny one. I literally breathe into a crystal while I'm doing that. I am thinking my intention. I'm breathing my intention into the crystal. There is power in the breath."

Oh-Shinnah said that before actually going to work on a patient, she does an assessment by moving the crystal through the person's electromagnetic field to find out what is in the field itself. "I council with them to find out if the problem they are having is a current life problem, a childhood problem or a past life problem.

"I use everything in healing -- color, therapeutic touch, tones -- anything that works. The crystals work within the realm of sonics very well. They resonate with a tone. I believe I've figured out a way where I can recognize the tone in the crystals just by holding the crystals in my left hand, which stimulates activity in the right brain hemisphere, or the creative, intuitive process, and then listening and duplicating what I've been hearing in my head, and singing that tone. I've learned to vibrate tones or frequencies that open the solar plexus and heart chakras so healing energies can be taken in.

"If I'm working with a cancer patient, I would breathe an intention into the crystal to help this person to heal. If the specific problem was cancer of the liver, and I've programmed the crystal to work specifically with those problems, sometimes I'll

be working on the liver where the disease is and all of a sudden the crystal is moving up to where the heart is. This tells me that the reason the person has cancer in the first place is because they are blocked in the heart chakra. So I start talking to them and sure enough, they are very blocked individuals," she continued. She also noted that crystals can be used to remove pain.

NURSES WILL CHANGE THE PRACTICE OF MEDICINE

Oh-Shinnah has been doing workshops for the past five years. She estimates that she has trained 40,000 people, mostly nurses. Further, she believes that nurses will eventually change the entire medical profession, moving it toward a more holistic approach. Oh-Shinnah stated that it takes two to three three-day workshops to acquire a beginner's knowledge and ability in working with crystals, in addition to a good deal of practice.

Presently, Oh-Shinnah is involved in a research project with Dolores Krieger, Ph.D., director of the Ph.D. and Masters program at New York University School of Nursing and author of "Therapeutic Touch" and "Foundations For Holistic Health Nursing Practices".

"Primarily, what I'm doing with Dee is research on what is going on with natural quartz crystals and therapeutic touch because we've had some results that we don't understand," Oh-Shinnah said. "You see, one of the reasons the medical community listens to me is because of results. I don't have a great deal of research yet on how or why it works, but they've already seen that it does work.

"Dee and I were doing a workshop in California. It was around Easter time and this particular little girl and her father were coloring Easter eggs. She and her father had a fight and she pulled the pot of boiling water over on herself and received third degree burns on her legs. They took her to the hospital and shot her up with Demerol. They said she would not even be able to be on her legs for three weeks and that healing would not set in for a long time. She was still in agony when they brought her to us.

"Dee immediately started doing Therapeutic Touch and I started working in the same area with the crystal. All of a sudden, I felt the crystal tugging at me and I realized it was heading toward the solar plexus. What happened was that in her anger, she pulled the water over on herself and tightened up her solar plexus (stomach area) so that the energy of fear and shock were contained in that area. She was holding it there and not in her legs. So I started working in that area and as I did, Dee started getting discharges of energy into her hands so fast she had to call in another nurse trained in Therapeutic Touch to help ground her.

"There were 30 people standing around us and we literally watched all the red peripheral area start to move in and shrink. All of the blisters infiltrated and then, very slowly, this kind of filmy substance went over the third degree burn area. That little girl was on her bicycle the next day and was free from pain from that moment on.

"So we started saying, hey, something is going on here. The crystal, being a magnifier, would magnify the intention of Therapeutic Touch in addition to its own healing properties. Therapeutic Touch elevates the hemoglobin in the blood and changes the enzyme system. Dee and I are going to try to replicate these experiments to see if there isn't some way we can test what happens with a patient, first with just Therapeutic Touch and then with Therapeutic Touch and the crystals. We're looking to find out if healing increases using both techniques. This will probably be done at New York University."

GIFT CRYSTALS ARE PREFERABLE

While Oh-Shinnah insists that anyone can be taught to use a crystal, she stated, "It is our tradition that crystals should be given to you. To allow a crystal to come to you is an indication from other energies that it is time. I think the Western World is in a very big hurry. I call it spiritual materialism. Everybody wants it all now; they don't perfect anything they learn. They learn a little about something and they do tremendous damage because they are not experts. The Western world thinks they can go out and buy everything. They are all looking for miracles to happen in their lives and they ignore the little miracles, like maybe just developing enough patience to allow things to be given to you. Buying a crystal programs it immediately with the attitude that 'I can buy whatever I want!'"

Oh-Shinnah added that it is possible for a person to buy his or her own crystal in the event that one is not given to them. These can be worn for protection and for heightening one's own energy field. The crystal used in healing, however, should be one given to an individual.

People interested in Oh-Shinnah's workshops should contact the Four Dimensions Foundation, 632 Oak St., San Francisco, CA 94117. (From the July-August 1981 issue of "Expansion", bimonthly, \$12 a year, 1212 W. Lill, Chicago, Illinois 60614)

"TWENTY-TWO GEMS, STONES, AND METALS"

For those of you interested in the scientific and occult properties of Crystals, the 50-page brochure of the above title on gems, stones and metals put out by the Edgar Cayce Publishing Company, Virginia Beach, VA 23458 is a good place to start. Write for latest prices and postal charges. Part I of the brochure explains the Mechanism of Influence, Stones and Metals for Attunements, for Protection, and for Destruction. Part II contains references in the Cayce readings to specific Crystals for specific purposes, agate, amethyst, beryl, bloodstone, carbon steel, chrysolite, copper, coral, diamond, etc., and Part III discusses the problem of Choosing a gem, stone or metal for one's self. There are extensive lists of suppliers, of periodicals and books on the subject, the Calendar of Birth Stones, and a Bibliography. Brochure was published in 1960.

THE CATHOLICS IN A QUANDARY: THE POPE? OR REAGAN?

By John Dart, LA Times Religions Writer
With CQC by the Editor

"Archbishop John R. Quinn of San Francisco surprised participants in a Mass Oct. 4, 1981 at St. Mary's Cathedral with a strongly worded pastoral statement saying in part, 'The Teaching of the Church is clear: nuclear weapons and the arms race must be condemned as immoral.'

"The occasion was the 800th anniversary celebration of St. Francis of Assisi, the 'prophet of poverty and peace' who is the patron saint for the city by the bay. Quinn received a standing ovation at the end of his statement and aides said the nearly 300 letters received since have been virtually all favorable.

"Quinn said modern Popes have recognized the right of nations to responsible self-protection against unprincipled and dangerous enemies. 'The moral problem arises, however, when the effects of our defensive weapons are no longer fully predictable nor within our control,' said Quinn, who served as president of the National Conference of Catholic Bishops 1977-80. Because of the wide-spread destruction envisioned in a head-to-head U.S.-Soviet conflict, Quinn contended that Catholic sanctions for 'just wars' do not apply in this area.

"'Strategic nuclear weapons are designed precisely and exclusively to destroy entire cities and their populations,' he said. 'It is hard to imagine a more lethal instrument in indiscriminate mass destruction of civilian noncombatant populations.'"

It is encouraging that American Bishops are now engaged in an agonizing reappraisal of their virulent anti-Communist policy. After World War II the National Conference of Catholic Bishops saw the atomic bomb as the ultimate weapon which would, if needed, destroy Communism and return Russia to the fold of the Church. Now they realize, to their horror, that if we engage in an all-out atomic war with Russia, there wont be any Church! Or any Bishops left to run it!

"Quinn quoted from a Pope John Paul address early this year (1981) in Japan: 'To remember Hiroshima is to abhor nuclear war. To remember Hiroshima is to commit oneself to peace. . . Let us promise our fellow human beings that we will work untiringly for disarmament and the banishing of all nuclear weapons; let us replace violence and hate with confidence and caring.'

"Quinn's statement was prominent among public positions taken

recently by as many as 28 U.S. Catholic bishops (only 10% of the American active hierarchy), according to a survey by the National Catholic News Service.

THE ROMAN CATHOLIC CONSCIOUSNESS NEEDS TO BE RAISED

"Although Quinn called for efforts toward 'bilateral disarmament', he urged that his own archdiocese take several steps characterized as 'consciousness raising' by Thomas Ambrogi, executive director of the social justice commission. The archbishop asked that one day a month be set aside for fasting and prayer for peace and that schools and parishes be informed about the nuclear arms race.

"Quinn backed 'active cooperation' with groups seeking signatures for a California ballot initiative endorsing a nuclear weapons freeze appeal to the two superpowers when that petition campaign begins Dec. 1."

It seems likely now that California citizens will have a chance to vote for a Nuclear Arms Freeze in the General Elections in November this year, 1982, a significant addition to the rising international chorus of protest to atomic suicide. Catholics now face a clear choice, accepting Communism as one of the facts of life and living with it, or martyrdom in a nuclear holocaust. President Reagan and his Secretary of State, Alexander Haig, have already decided for the latter. They have been well programmed by MIRO, those members of which have made, and want to continue to make millions of dollars in profits from the production of fissionable material and of atomic weapons. The Church itself, with massive investments in munitions industry stocks and bonds, has profited from this military madness. But, as far as the Satanic forces who engineered this insanity are concerned, the nuclear arms freeze effort is too late. There are already more than enough atomic weapons manufactured and in place to wipe out civilization. All it takes is some military maniac in Washington or Moscow to pull the trigger.

"Father Miles Riley, a spokesman for Quinn, said the archbishop's statement has 'John Paul mentality all the way through it.' Catholic opposition to the nuclear arms race is nothing new, Riley said, except that it is now 'out of the closet'.

"After once tabling the motion, the National Council of Catholic Women's 1,400 voting delegates at their annual meeting earlier this month went beyond any previous stance they have taken and approved overwhelmingly a resolution that incorporated the Pope's words to work tirelessly for disarmament and nuclear weapons abolition. A proposed amendment to 'also support the Reagan Administration's military policy. . . in its fight against Communism' was ruled out of order because of its contrast with the intent of the resolution. Earlier, several bishops had been more specific in their opposition to the arms race.

"Bishop L.T. Matthiesen of Amarillo, Texas urged employees to quit their jobs at the nearby Pantex plant, which does the final assembly work on nuclear bombs and the neutron weapon. Matthiesen said he was not requiring Catholics among the 2,400 employees to resign, 'I want them to listen to their own consciences. I'd say the same thing to anyone working in an abortion clinic. And nuclear weapons are anti-life supreme.

"The two Catholic bishops of Montana, Elden F. Curtiss of Helena and Thomas J. Murphy of Great Falls-Billings, said in September that they would oppose not only the deployment of the MX missile in Montana but also 'the MX missile system itself, since it contributes to this escalation (of the nuclear arms race).' They cited Pope John Paul's charge in his United Nations speech two years ago that the desire to be ready for war means being able to start it.

PROTEST BY REFUSING TO PAY TAXES

"Archbishop Raymond G. Hunthausen of Seattle, an advocate of unilateral disarmament who had picketed earlier against the nuclear-armed Trident submarines based in Washington state, called for Christians to protest the arms race by refusing to pay half their income taxes.

"Hunthausen stirred wide debate with his call to conscience and his contention that the failure of disarmament talks 'leaves us with only one moral position in this tragic situation, the position of unilateral disarmament with trust and reliance on the Lord as our security.'

THE JESUITS' UNILATERAL POSITION: SUICIDE!

"Jesuit Father James V. Schall, in a column for the San Francisco archdiocesan paper, the Monitor, said the Seattle archbishop's position 'is something that is not all required either by reason or by Catholic teaching. Schall, associate professor of government at Georgetown University (in Washington, D.C.) said the church 'has not embraced a position of unilateral nuclear pacifism.' Citing the remark of another bishop, Schall said, 'If the Pope were to have changed the traditional Catholic doctrine on the just war theory, he would have done so in a frank and open way. He has not done this.'"

The holy war to save hundreds of millions of dollars worth of Church property in Vietnam from expropriation was a "just war" in the eyes of the Church prelates -- as is the present conflict in Latin America between the Church and the land barons on the Right, and the guerilla rebellions on the Left. Again Rome is hopeful that the force of American arms, and American lives, will stop the irresistible shrinkage of the Holy Roman Empire which began with the loss of French Catholic Algeria and Spanish Catholic Morocco in Africa after World War II. The only support America got from Italy in the Vietnam war was a hospital ship to patch up American soldiers so they could get back to the fighting at the front.

"Father William V. O'Brien, a government faculty colleague of Schall's at Georgetown (the Jesuit university in the nation's capital), said Hunthausen, Quinn and some other bishops 'never talk about the nature of the threat. They don't counsel us as to what we're supposed to do. They only address one part of the dilemma. . . and take an abstract moral attitude.' . . The Jesuit professor said the bishops are making a 'meaningless distinction' O'Brien said the nation has to have a credible intention to use the weapons in the event of a challenge.

THE JESUIT SOLUTION: ATOMIC IMMOLATION

"Author of 'The Conduct of Just and Limited War' to be published next month (November 1981) by Prager, O'Brien said it appeared that Archbishop Quinn and others have the assumption that there is only one kind of nuclear war. 'I think that you can fight 'just wars' at a lower level,' he said, asserting it is difficult but possible.

"By contrast, Quinn questioned the promotion of the neutron weapon as a 'Theater' or 'tactical' weapon. 'Its use' said Quinn, could easily ignite a global nuclear confrontation. It contributes to the dangerous illusion that a 'limited' nuclear war can be fought and won."

"Repeating a theme stated by Pope John Paul and other bishops, Quinn said the billions of dollars spent for arms are 'an appalling form of theft in a world where so many persons die each day of starvation and privation.'" (LA "Times", Oct. 24, 1981)

Russian leaders have no illusions about the impossibility of a just, limited nuclear war, or the delusion that President Reagan can continue encouraging his billionaire friends to make more atomic weapons without increasing the chances of a planetary holocaust. Read the measured words of General Nikolai Chervov, of the Soviet General Staff, in a letter to the LA "Times", Feb. 12, 1982:

"The U.S. concept of a 'limited' nuclear war is built on the misunderstanding of the essence of the matter and a striving to make the idea of a nuclear war acceptable to the public, to con people into believing that a nuclear conflict can supposedly be confined to narrow limits. This concept has nothing to do with reality and is only misleading. This is dangerous. . . We Soviet people are asking a natural question: Why is all this being done? The only goal is obviously to persuade the American people that nuclear war is admissible, possible and even inevitable, to scare them into accepting the Reagan Administration-launched unparalleled race for weapons. . .

"We believe that in today's conditions a 'limited' nuclear war is not possible. Speaking militarily limited means several hundreds, at least several dozen nuclear strikes. Can one really imagine the other side meticulously counting the number of strikes and saying, 'We have been hit with 80 blows, so we must retaliate

with 80 blows as well.' After all, each side will have quite definite targets which it intends to knock out at each given moment. Is it possible that it will not surpass the limits of what the enemy side considers possible? The answer is surely in the negative.

"Speaking in practical terms it is utterly unrealistic to expect the enemy side to retaliate with the same number of strikes that it had been hit with in conditions of war, with the systems of communication and control disrupted.

THE "BUNKER STRATEGY" OF THE PENTAGON

"The U.S. press carries articles on the problem of survival in a nuclear war, and on the so-called 'bunker strategy' for ensuring an 'underground foundation' for the Pentagon's doctrine of a 'limited' nuclear war. We Soviet people are asking a natural question: Why all this is being done? The only goal is obviously to persuade the Americans that nuclear war is admissible, possible and even inevitable, to scare them into accepting the Reagan Administration-launched unparalleled race for weapons. Herein lies one of the main dangers inherent in Pentagon propaganda about the 'bunker strategy' and survival in a nuclear war. . .

"The Soviet Union emphatically denounces any calls for war and a preemptive strike. The Soviet military doctrine is purely defensive in character. The Soviet Union regards a nuclear attack as the gravest crime against humanity. An attempt to ascribe to the U.S.S.R. some perfidious first-strike scheming made, in part, in the Pentagon's 'Soviet Military Power' is meant to sidetrack public attention from one's own militaristic doctrines. . .

"When Secretary of State Haig or Secretary of Defense Weinberger officially declare that the United States will not stop at anything, the use of nuclear weapons included, the Soviet Union must obviously think about the defense of its state interests, to be ready to give a proper response to a nuclear attack. . . only an emergency situation, that is, aggression against the U.S.S.R. and its allies, may compel the Soviet Union to resort to this extreme means of self-defense. In all other cases we deem the use of nuclear weapons utterly impossible.

"So why **commit suicide**? After all, both the U.S.S.R. and the United States have weapons that make devastating retribution possible even under the most unfavorable conditions. No bunkers will help. Only out-and-out adventurists and liars may assert that a 'limited' application of nuclear weapons can save civilians from the horrors of Hiroshima and Nagasaki. Like reckless gamblers they are talking about one war, two wars and the like. It is a tragedy when such people become policy makers. This calls for unremitting vigilance."

General Chervov is right. We now have policy makers in Washington who will cheerfully lead us down the road to atomic suicide. Satan doesn't care who starts the conflict, just so it achieves His goal of ultimately destroying mankind and the planet. It will take heroic efforts by millions of men and women of good will everywhere to stop this military and religious madness.

TENS, THE ELECTRONIC WAY TO STOP PAIN

Adapted from Kiplinger's "Changing Times" Magazine

"For eleven nightmarish months, Vito Rainert was almost totally disabled by agonizing headaches. He could not work or do much else. Today, the 45-year old machinist from Canastota, N. Y., leads a normal, mostly pain-free life. The headaches still come occasionally, but he gets rapid relief by flipping a switch on a small electrical device he always keeps close at hand.

"Rainert is one of a small but growing number of pain-sufferers who are using low-voltage electric current to make life bearable. The method, little noted outside of some health circles, is known as Transcutaneous (meaning through the skin) Electrical Nerve Stimulation. The equipment consists of a battery-powered impulse generator, or stimulator, with wires leading to two or more electrodes that can be placed on various parts of the body. When a knob is turned, pulsating current passes through the painful area.

"In some way -- nobody knows just how -- the pulsations deaden or completely obliterate certain kinds of pain. Relief can last for hours, even days, after application."

The author of the "Changing Times" article fails to mention that these TENS devices are ELF wave devices, with the pulsations down in the 1 to 20 cycles per second area of Extreme Low Frequency, and the little 9-volt transistor battery is power enough. This is the well known brain-wave area, Alpha, Theta, etc., the basic rhythm of the body's auric field, 7 to 8 cycles per second, and the Schumann resonance of the earth's electro-magnetic field, 7 to 8 cycles per second. Food for thought, isn't it?

"Electrical stimulation is not a cure for underlying disease. Nor does the therapy work for everyone or help all kinds of pain. There are cautions, too. The electrodes or contacts should not be placed over the carotid arteries on the sides of the neck. Persons with cardiac pacemakers should avoid using TENS. Whether electrical stimulation is safe to use during pregnancy is uncertain, but it has been used to ease the pain of childbirth.

"Even though TENS has its limitations, its achievements are impressive. Currently between 25% and 80% or more of chronic pain victims and 80% or more of those with acute pain who use stimulators get partial or complete relief, according to clinical stu-

dies and health care professionals. (Chronic pain lasts indefinitely; acute pain is sharp and short-lived.)

- At the Hadassah University Hospital in Jerusalem, 284 patients treated with Israeli TENS equipment were studied over a five-year period. Results were good for 153, moderate for 75 and poor for 56. Conditions included neuralgia of various kinds, peripheral nerve injury, postoperative pain, herpes zoster (shingles), cancer, low-back pain and cervical spine syndrome.

- In a Swedish study, TENS was administered to 147 women during childbirth; 65 responded good to very good relief, 65 experienced a moderate effect and 17 said there was no effect.

- Reporting a study of 120 patients with varying pain syndromes, Dr. Richard L. Steig of the University of Colorado Medical Center said 83% obtained fair to excellent relief with TENS, whereas 17% got little or none.

- In Kansas City, physical therapist Gerald Lampe has treated over 3,000 patients with stimulators, with good responses ranging from 25% to 80%, depending upon the problems.

- More than 700 chronic pain victims have been treated with TENS in a pain-rehabilitation program conducted by Dr. Ronald Dougherty in Brewerton, N.Y., near Syracuse. He is the physician who prescribed electro-stimulation for Vito Raineri. Of the 700, says Dr. Dougherty, '60% have gotten good relief, meaning a marked subjective decrease in pain, an increase in motion and a discontinuance of drug use'. For 13% the results were fair, and for 27% results were poor.

"Dr. Dougherty is particularly pleased with TENS success in reducing drug use and addiction. When only medication is used, '40% of the people with chronic pain will take from one to five drugs, and 25% of those will become addicted. Those figures come from studies at our clinic, the Mayo Clinic and other pain clinics throughout the country."

The success of these ELF wave devices can only be a source of exasperation, even rage, to the pharmaceutical companies that are making millions off the sale of pain-killing drugs; so it isn't surprising that the AMA has shown little enthusiasm for setting up a research program and putting its stamp of approval on TENS; and that the FDA "has not developed performance standards for manufacturers" of the devices.

THE TRAGEDY OF DRUG-INDUCED STUPOR

"In Dr. Dougherty's program, urine tests are conducted to find out whether patients have in fact stopped using drugs. He adds, 'We find that many people are not only immobilized by pain, but also by the drugs they are taking!'

"New patients are given a series of about seven TENS treatments. If all goes well, the person gets a prescription for

for leasing a unit for a month. After that, if the results are favorable, a check is done to see whether purchase of a unit is covered by the person's insurance.

TENS A DESIRABLE ALTERNATIVE TO DRUGS

"TENS has been declared safe and effective by a panel of advisers to the Food and Drug Administration and various other investigators, including several nationally prominent physicians who specialize in pain control. The therapy is considered an alternative to widely used remedies, such as aspirin, which can irritate the stomach the stomach lining and sometimes lead to ulcers. Researchers at the Pain Treatment Center at Johns Hopkins Hospital in Baltimore found that chronic pain patients often receive inappropriate treatment, including numerous operations and excessive use of drugs.

"Electrostimulation produces no known side effects, although the electrodes can, in some cases, cause minor skin irritation that is easily treatable. The current can cause a somewhat unpleasant, but not dangerous, jolt if it is suddenly turned up by accident (some stimulators are designed to prevent this); otherwise it produces a mild tingling sensation.

"The typical stimulator is slightly larger than a cigarette package, but at least one brand is half that size. The units can be carried about or worn -- on a belt clip, in a pocket or brassiere, for example -- even during vigorous activity. One type attaches to the arm or wrist.

"The question of how electricity affects pain intrigues scientists and those in the health professions. The consensus now seems to be that one or two things -- or possibly both -- happens: The current overloads part of the body's nerve circuitry, blocking pain signals to the brain, as one theory called the Gate Control Theory suggests; or the current triggers a natural defense mechanism, causing the brain to release morphinelike substances called enkephelins and endorphins. Acupuncture creates an almost identical effect (see 'Acupuncture: A Curious Cure That Works', Nov. 1980)."

A third alternative suggests itself: the healing effect. Suppose pain is caused by a temporary or permanent blockage of the flow of nerve energy, and the TENS current does indeed "overload the body's nerve circuitry" in that area and forces the body's nerve energy to flow again, relieving the pain? If the removal of blockage is permanent, a cure has been effected. The writer of the Kiplinger Newsletter article does not dare mention this; but English researchers have discovered and proven the healing effect of ELF waves in clinical research, in some cases, and such claims are made for some of the English TENS devices, such as the Monad "Magnapulse" which sells for \$80. It has no electrode contacts but depends on entrainment of the body's field with that of the Magnapulse device, at from 1 to 20 cps.

ALL PAIN IS PSYCHOSOMATIC!

"Why some people respond to TENS and others do not is also a mystery. No doubt a few patients merely **imagine** they feel better. This placebo effect seems to occur with all kinds of pain treatment. Also, some pain is psychosomatic and doesn't respond to any orthodox treatment."

We have one Associate, Komar, who controls pain with his imagination -- or someone's imagination! -- when he walks painlessly over a bed of white hot coals, or lies on a bed of spikes. Conscious control of pain is one of the marks of an adept, on both the Right and Left hand Paths. This is one aspect of the developed Will, and demonstrated daily by the Faqueers attached to the temples in the Orient.

Because Pain is the great teacher of mankind in the world today, the person who overcomes pain by an effort of his or her will may miss an important lesson in morals and ethics, and unwittingly choose the Left Hand Path of Evil. The Master D.K. refers to this in his "Letters On Occult Meditation" to Alice Bailey: "Anyone who over-exalts the concrete mind and permits it continuously to shut out the higher, is in danger of straying on the left-hand path. Many so stray -- but come back, and then in the future avoid like errors in the same way as a child once burnt avoids the fire. It is the man who persists in spite of warning and of pain who eventually becomes a brother of darkness. Mightily fights the Ego at first to prevent the personality so developing, but the deficiencies of the causal body (for forget not that our vices are but our virtues misused) result in a lop-sided causal body, over-developed in some direction and full of great gaps and gulfs where virtues should be. . . "

"TENS is used with and without medication," continues the Kiplinger article. "The therapy in some patients significantly lessens the need for painkilling drugs and can prevent or help bring an end to narcotic addiction, which afflicts about 25% of all chronic pain sufferers. Stimulation often results in quicker, narcotic-free recoveries for many surgical patients.

"For some pain victims, stimulation has helped after all else has failed. Vito Raineri consulted three physicians, took an assortment of drugs, some by injection, and even tried oxygen before consulting Dr. Dougherty. . .

"Stimulators are available only by prescription in the U.S.; in Japan and several other countries they are sold over the counter for as little as \$150. In the U.S. stimulators retail for between \$500 and \$600, but one manufacturer, Dow Corning, has a disposable model for acute pain only that is sold to doctors for \$35. Its power lasts for about 150 hours. For pain sufferers who shell out hundreds of dollars a month for drugs, TENS at \$600 could be a major money saver. The costs qualify for reimbursement under medicare and several private health insurance plans.

"One TENS pioneer is Dr. C. Norman Shealy, director of the Pain and Health Rehabilitation Center in La Crosse, Wisconsin. He has treated more than 3,000 patients with TENS and says that even the number of physicians aware of TENS is 'pathetically low'. Nevertheless, TENS is now being adopted by more and more hospitals, pain treatment centers, physicians and physical therapists. A number of professional athletes also make use of the device. . . . TENS is used most commonly to combat low-back pain, which strikes half the population of the U.S. at one time or another. . . . More and more TENS is being used to ease pain that follows surgery. . . . TENS can also be effective against the pain of osteoarthritis. . . .

DISCOVERED BY ACCIDENT

"In the late 1960s Wisconsin's Dr. Shealy, assisted by Prof. J. Thomas Mortimer, began implanting electrodes in the dorsal column of back-pain sufferers. Because that procedure didn't always bring relief, they sought to determine in advance whether a patient would respond to the use of stimulation by placing electrodes directly on the skin. To their surprise, they found that this alone often did the job!

"About that time a small company called Stimulation Technology, Inc., or Stim Tech, was formed in Minneapolis to produce a portable stimulator. In 1974 Stim Tech was acquired by Johnson & Johnson, the world's largest seller of health care products, and Stimtech's three principal organizers, Norman R. Hagfors, Stanley MacDonald and Clayton Jensen, became executives of a J&J division set up to produce the devices and put them on the market.

"In 1979 the three sued J&J, charging fraud, antitrust violations and failure to honor an agreement to vigorously promote the stimulators. Instead, they contended in their trial brief, the company 'tried and succeeded in suppressing competition between stimulators and its pain-control drugs. With Tylenol ascendant in the drug market and Zomax in development (A new drug that has since been introduced), defendant was not about to permit Stem Tech to educate the public on the benefits of stimulation over drugs.'

"After a five-month trial in 1981 the jury awarded \$170.4 million in damages to the three plaintiffs. In the judgment decree, Judge Miles W. Lord said the 'overwhelming weight of the evidence...established...that the defendant engaged in fraud and other misconduct of the most extreme and culpable nature.' J&J assails the charges and the verdict, which the company is appealing as absurd, and predicts it will win. 'To suppress TENS we'd have to buy 10 other companies.' a representative asserts. Actually, the number of competing manufacturers now exceeds 50 and includes such giants as Dow Corning and 3M corporation. . . . these pulse generators, like electronic calculators and a host of other products, may drop in price as competition heats up and demand swells . . . and there should be a dramatic decrease in drug use. Asserts Dr. Shealy, 'Electrical stimulation has more to offer than all of the drugs combined.'"

CLIPS, QUOTES & COMMENTS —

AH, THOSE CAVERN WORLD CONNECTIONS!

"Do you folks remember the story of two little green-skinned children seen coming out a cave in Europe generations ago? I've read it a few times in paperback books on ancient astronauts. The local magistrate, local priest and other leaders signed papers saying the experience was true. One child died. The other was raised and told of a cavern life a la Richard Shaver's data. Listen! Under the corporation of Texas Instruments are super long tunnels and in one of these are many large cages containing little green people! The true story comes from a woman who lives in Garland, Texas. She and a near relative worked for years for T.I. Dero ray wont let her recall this other woman's name, who, along with a few others was chosen for clearance for a specific project. They were taken down this extremely long tunnel and stayed there for some time to observe all these little green men and women. After retiring, the woman got drunk one night and spilled the story. Both the Dero 'have-nots' and the Tero 'haves' desire that surface man never finds out about the underworld. Some have to lie or they will receive Dero-ray harm. Shaver wrote that your BSRA group is in that position. Dont blame your contacts. Mental Ray control has you and Shaver fans controlled very well -- along specific thought-patterns wanted. Thus I'd be very surprised if I found out later your fine group had spread Ruth's story about T.I. all around."

Henry M. Steele, Garland, Texas

The inhabited interior of the earth, a fascinating and dangerous subject, for the majority of surface-dwelling human beings who have no control over their emotions. It is true that no surface-dweller can be successful in a material way without the help and cooperation of inner earth Forces; for they control matter; so it is not surprising that a highly successful firm like TI should have inner earth contacts. What is surprising is that some of the directors have conscious knowledge of such sources of power and should risk exposure by sharing that knowledge with some of their lower level employees. For, as Henry says, the Deros are very successful in keeping such information secret -- except to the initiated! The danger is that the initiated, uninformed person who opens himself or herself up to such Forces will be overwhelmed by Them and learn too late that They are controlling him! or her!

This is why we quote Max Heindel at the beginning of our talk on "The Reality of the Cavern World" (BSRF 2-E, \$3.00 postpaid.) From his "Rosicrucian Cosmo-Conception", the chapter on the Constitution of the Earth: "Even among occult scientists it is counted among the most difficult problems to investigate the mysterious

construction of the earth. To do that fully one must have passed through the Nine Lesser Mysteries and the first of the Great Initiations."

In Christian terms the signs of the first Great Initiation are three: 1. The prophecy of the coming Messiah, 2. The Annunciation by Gabriel, and 3. The ministry of John the Baptist. This is really an interior experience of the soul or Higher Self as it prepares for the Birth of the Babe in the heart. These three signs tell of the awakening of the conscience, pressure on the Lower Self or personality to change its worldly ways from getting to giving.

MEETING THE EARTH GODS FACE TO FACE

Hawaiian Kahuna David Kaonohiakala Bray, talking to students in Los Angeles, Feb. 21, 1963:

"It was about three years ago, My wife had passed on. We had a beautiful home up in the heights above Honolulu. I was lying down on a punee in the parlor. I heard a noise and felt a peculiar feeling coming over me, more like electricity going in you. I have had these feelings before, when I was sleeping. I know it is not the Forces I want -- because once they take over, you're frozen! You cant move, nothing!

"You try to yell. When I was sleeping with my wife, we try to pinch each other; for as soon as we touch each other, we break it. Then I knew. They're coming. I sat up and started to pray to the Great Power, to the Great Aumakua to protect me from these Forces. I dont want to be taken over. But it came down.

"Then I heard this voice, 'David, dont call because we have closed the door.' Then I saw three men walking, one in front -- like the Egyptian gods -- and the other two behind, walking. By that time I was frozen. I wanted to yell. I couldn't yell. But I could talk!

"'Now David,' he said again, 'dont call because the door is closed. They (David's grandchildren elsewhere in the house) can not hear you. You asked me to come and so here I am.'

"'I didn't ask you. I've never seen you before!' He was not the same person I had seen before. So he explained how we had met and what we had been through. Then I knew I had been through things without thinking. Then I came to myself and knew it was not me -- all these little things that had happened, peculiar experiences, not to hurt anyone -- some day I'll tell this to the one before I go.

"Finally he says, 'David, we own half of the universe, the Great Power. Light owns the other half. We are not bad in our world. Your world make us bad. Many of your great people, David, holding high positions, tops. When they come here they become our slaves; because they have made use of us for their wants; and we want that because when they become our slaves we have fun. But we are not bad, David; and many of your richest, the highest

among your people, in your world. They come here and they become morons.

"I had never heard that word and I said, 'What is that?'

"And he said, 'Like your feeble minded homes. Like them, we kick them around. We have fun. Why? Because they make use of us, and then they cant pay a big debt.'

MASTERS OF HUMBUG AND DECEIT

"'Many of your people in your world. Their tongue goes to the great Power, the great Light; but their hearts are with us! So then when they come here we kick them all over the place. David, we've been with you. You push us. We mean no harm. We love you. Just leave us alone. I have saved you with my company, many a debt.' -- Because I've been in many troubles, between life and death -- 'Just leave us alone. We like to be near you people in your world. But dont make us do things that we must hurt you. I dont want you to be a slave here, in our world.'

"At the same time I was asking God, please! Take these Forces away because I couldn't move. Then I look again. In the beginning he was like a statue. But now I look, he was human. Fine eyes. He was stern, as though he could look right through the wall, but he became softer, more real. He told me a few other things.

"'We have a great company, great organization, also like what you have in your world, David. We have little groups. We have individuals. I am the Prince of my own, and my name is so-and-so but you are not to reveal this. This is for yor own protection, your own -- uh, to help you. And we have the lowest Forces here, too. Many of the people in your world are playing with them. David, dont play with them.

"Then he says, 'Now David, we're going. Remember this, we love you. Dont push us. Just leave us alone and we like to help people.' See, this is a peculiar thing. So he look at me, nice. It was a kind feeling. Soon as he left -- the door closed -- I could hear going, bang -- we have house like Chinese style inside. That thing went down (a sliding screen) like something went out of you.

"I ran into the kitchen and got salt and put it in water (Pa-akai salt from the Pacific, evaporated in shallow rock pools along the Hawaiian shores, appropriate for Huna rituals) to sprinkle the whole house. To me he was a devil. Later on I thought they mean well. It is us that are greedy, selfish. We are making them do all this because they own half and the great Light own half

"Only to half a dozen people I spoke this. Some say God controls everything. I say this is reason Christ came, to show that the devil has power if we let him get us. To the Hawaiians there are two great Forces, the Highest and the Lowest. The

Highest -- like the Goddess Pele and all these -- they are from the Negative. They belong to the Fire but they are the ones to contact, these Forces, to help mankind. The great Negative Forces want to do what is good, to try to help us.

"It is the other half, part, that wants trouble, mischievous, to make a fool of us. This is the thing we have to be very careful, and to understand, to know them. I've seen this in many people here. I've seen this and proven. It's fun here, while we're living; but who's going to pay for it? Themselves! And sometimes they don't have to wait to go there to become their slaves. . . "

So David Bray learned by direct experience -- as all must learn who penetrate the Veil of the Mysteries -- the difference between God-the-Creator and God-the-Destroyer, and the functions of His representatives and agents here in the lower worlds.

WHAT SAYS THE MASTER?

"Man stands indeed upon the threshold of discoveries, of revelations, of the attainment of powers such as have not been known since the days of the Atlantean Race. And herein lies his danger. Unless, this time, he is morally strong enough to control these forces and develops that spirituality of outlook essential to all those who wield great power, once again he will be overwhelmed; once again he will be swept to destruction by the very forces which are designed to be his benefactors.

"It is from this, the fell fruit of his own ignorance and pride, that we seek to protect him; and it is to this end that I desire to reveal to you some of the difficulties which must be faced and overcome if man is to learn to contact the devas with impunity.

"For again I would stress that the devas respond to the creative vibrations a man gives forth. to the Note of Will or of Love or of Activity that he sounds upon the aeolian harp of the Inner Worlds. As his motives are, so will his note manifest there, either in harmony or in discord; in floods of exquisite colour or suffused with the shades of his own aura -- and according to this Note will be the type of devas he attracts to himself.

"And herein lies the key to the dangers which attend this fusion of the human and deva lines of evolution; for although both are united in aim and are proceeding towards one goal, their natures are utterly unlike. The devas are not possessed, as is man, of a sense which differentiates between right and wrong; therefore, because of their very nature, void of error or of the possibility thereof, those who function on the lower planes of the Astral and Etheric can be used by man for good or for ill.

"Only those possessed of a clear understanding of the fundamental laws of nature can, therefore, hope to invoke the devas with safety. For if a man attempt so to do before he has learned a great measure of control over his emotional and mental bodies,

under the tremendous outpouring of force which his invocation will draw upon him he may easily be overpowered and driven eventually to what men, in their ignorance, mis-name madness. . .

DISCORD MEANS EVENTUAL DISINTEGRATION

"Should any seek to use the devas with deliberate intent for selfish or destructive purposes, let him beware! Eventually the result will be disaster; for the note he sounds will be a false one, setting up a dissonance with the creative note of the divine Will; upon this discord the deva essence will vibrate with greater and greater momentum until the man can no longer control it. Gradually the increasing vibration will begin to disintegrate his bodies until finally they will be destroyed by paralysis, apoplexy, or by the slower process of some cancerous disease. (The drug-soaked final years of the late Howard Hughes come to mind. He wanted fabulous wealth and power, and the devas saw to it that the millions piled up to billions. Father Janssens, previous head of the Society of Jesus, died of apoplexy in Rome; and the present Father General, Pedro Arrupe, has been laid low by a stroke.)

"Finally -- I say: this may not happen in one life. Be it known to you that those who in Atlantis and even in later times thus trafficked with the devas, have been forced to reincarnate with the discord which they themselves created sounding still within them; vibrating ever upon their etheric matter it causes ill-health, disease or death according to its strength and their own weakness. It must eventually be transmuted by the man himself into harmony through service and through love; and he is ready to be 'cured' only when his note peals forth once more in unison."

Hilarion

(From: "Watchers of the Seven Spheres" by H.K. Challoner, George Routledge & Sons, Ltd., London, 1933)

A PROFESSIONAL DISCORD-SOWER AND MILITARY GANGSTER CONFESSES

"There isn't a trick in the racketeering bag that the military gang is blind to. It has its 'finger men' to point out enemies, its 'muscle men' to destroy enemies, its 'brain guys' to plan war preparations, and a Big Boss supernaturalistic capitalism.

"It may seem odd for me, a military man to adopt such a comparison. Truthfulness compels me to do so. I spent 33 years and 4 months in active military service as a member of our country's most agile military force -- the Marine Corps. I served in all commissioned ranks from a second lieutenant to Major-General. And during that period I spent most of my time being a high-class muscle man for Big Business, for Wall Street and for the bankers. In short, I was a racketeer, a gangster for capitalism.

"I suspected I was just a part of a racket at the time. Now I am sure of it. Like all members of the military profession I

never had an original thought until I left the service. My mental faculties remained in suspended animation while I obeyed the orders of the higher ups.. This is typical with everyone in the military service.

"Thus I helped make Mexico and especially Tampico safe for American oil interests in 1914. I helped make Haiti and Cuba a decent place for for the National City Bank boys to collect revenues in. I helped in the **raping** of a half a dozen Central American republics for the benefit of Wall Street. The record of racketeering is long. I helped purify Nicaragua for the international banking house of Brown Brothers in 1909-12. I brought light to the Dominican Republic for American sugar interests in 1916. In China, in 1927, I helped see to it that the Standard Oil went its way unmolested.

"During those years I had, as the boys in the back room would say, a swell racket. I was rewarded with honors, medals and promotion. Looking back on it, I feel that I might have given Al Capone a few hints. The best he could do was to operate his racket in three city districts. I operated on three continents."

This autobiographical confession by the late Major General Smedley D. Butler, U.S. Marine Corps cuts through present-day propoganda from Wall Street and Washington about why we are meddling in the politics of Latin America. There's only one thing missing from Butler's confession, his silent partner in all this criminal activity, the Church. He was probably a devout Roman Catholic himself. When America went into Vietnam to save hundreds of millions of dollars worth of Church property the French Catholics had been there only a hundred years. Imagine how much more vast the holdings are in Latin America where the Jesuits have had practically a free hand for over 400 years, and their trained frontmen still expect to be propped up on their tottering "thrones" by the force of American arms. Here's a relevant news item from the Los Angeles "Times", March 21, 1982:

"The Rev. Theodore Hesburgh remembers the first day he had **Jose Napoleon Duarte** in his class. He almost ejected the man who was destined to become the president of El Salvador. 'He was in the first class I ever taught at Notre Dame,' said Hesburgh, 65, who has been president of the South Bend, Indiana (Jesuit) university for 30 years. 'I threatened to throw him out the first day of class because he was talking Spanish with his brother. I found out later he didn't know enough English at that point, so I told him if he'd come by after class I'd give him a a lesson.' Duarte was graduated from Notre Dame in 1948, and Hesburgh remains his staunch admirer. . . ." until or if Duarte tries to make a deal with the left-wing guerillas in El Salvador. Remember the Roman Catholic dictator of South Vietnam in the early 1960s, Diem? He was a graduate of a Jesuit seminary in New Jersey. He came to realize that the Church's cause was lost in Indo China and talked of compromise with Ho Chi Minh -- and was suddenly dead in Oct. 1963.

THE DILEMMA OF THE FALKLANDS

It is true that the British took the islands from Argentina by force in 1833, but it is also true that the 1800 Falklanders who live there are British subjects who have no desire to live under a ruthless, brutal Roman Catholic dictatorship from South America.

"We go to the Argentine mainland and we see armed troops on the streets and 130% inflation and a state-controlled press and it is all completely alien to us," local customs official Fraser Wallace said in an interview before the invasion. "We are British and that's all there is to it. I have never been to Britain in my life, but I know I could never live under any other flag if the Argies come. I will leave and so will everyone else." (LA "Times", April 7, 1982)

This conflict of cultures goes back to the time when Henry VIII and his rapacious nobles sacked the monasteries and kicked the priests out of England. His daughter, Elizabeth, reigned for over 40 years and she used to boast of the number of unsuccessful Jesuit assassins who were sent from Rome to kill the hated, heretic English queen and put a Catholic monarch, Mary, on the throne. Thus the liberal, **Protestant philosophy** of Sir Francis Bacon and his peers dominates England and the United States.

The difference becomes painfully obvious to the American tourist who visits the Latin and South American countries to the south of us. They look to the Catholic nations of Europe, Spain, France and Italy for their cultural ties. It becomes even more painful if the tourist is thrown in jail for violating some local law and the religious absolutism of Rome is suddenly revealed. In America and the United Kingdom -- and in the Falklands no doubt -- a prisoner is considered innocent until he is proven guilty; but in the priest-dominated nations to the south a prisoner is considered guilty until proven innocent! Furthermore, he is likely to stay in jail until his trial, as there is no Writ of Habeas Corpus available to the victim of Roman jurisprudence.

The irony of the present situation is the **ambiguous position** of our leaders cast in the role of peacemakers. Secretary of State Alexander Haig is a devout Catholic and Prince of the Church, and President Reagan's sympathies with Rome are obvious. Their veiled threats of a First-Strike nuclear war against the Church's greatest enemy, Communist Russia, are a matter of record. Nevertheless something good might come out of all this. If Reagan/Haig succeed in defusing the British/Argentina conflict, the aura of success and international acclaim as peacemakers might encourage them to revive the Salt II discussions (Strategic Arms Limitations agreement) with Russia -- now languishing in the Senate -- and even listen to the rising national and international clamor for a freeze on the production of atomic bombs and weapons. If they don't, this could become the clearcut issue of the 1984 presidential campaign and threaten to propel a Democrat into the White House.

VOICE OF RESEARCH AND PROPHECY FROM DOWN UNDER

"One other thing we have found in using Radionics is that people who have blood transfusions run the risk of ectoplasmic infection from the donor at some stage in their lives. For example, if a donor, while healthy, gives you a pint of blood, then at a later date develops cancer within themselves, the minute particles (life cells) of the donor's blood may alter within the patient's bloodstream and may also produce cancer within the recipient. I believe once you have taken the blood of another person, some of their Life Force will remain within your bloodstream and will alter according to the state of health of the donor. I would like to hear from any Radionist who has discovered similar results along these lines -- apart from the Jehovah's Witnesses, of course.

"I sense that your Vice President is going to be your next president. As I visualise your President Reagan I see the Dark Forces gripping his heart; so I presume a violent heart attack is on the way for him. Your country has some big problems ahead and I am glad that I am living way down here.. Love and Light to you and your wife and may health and prosperity invade your life."

Morris Bradley, The Christian Spiritualist Union of NZ,
43 Colchester Crescent, Newlands, Wellington, New Zealand

ANOTHER PROPHET HEARD FROM, ON FATEFUL 1984

"A U.S. official or someone from the senate or congress may actually be taken aboard a UFO. Whether he is kidnapped or acts willingly as an ambassador is questionable. President Reagan and the CIA will try to cover up the whole thing. but the entire issue will be investigated and will create an uproar. There are also going to be drastic political conditions that will effect the world, but especially the American people. These conditions will have much to do with the 'secret empire' and the Eighth Head of the Beast."

This vision of Charles Marcoux confirms our own conclusions in 32 years of study of the UFO phenomenon; that official recognition of the presence of the Guardians and the Aliens from Outer Space means the end of civilization as we know it -- drastic political conditions indeed! For our civilization is based on the limited political philosophy that we are alone in the universe. The power of the Secret Empire -- or MIRO as we call it -- is based on this false concept. Once this falsity is exposed there will be a profound change in the consciousness of civilized man and MIRO will do everything in its power to maintain its control of the people, including violent political action.

"Reagan will win the next election by trickery, fear and confusion. I saw Reagan sitting on his high throne. There was no color around him (black and white effect) although his face and clothes were in color. I do not see Vice President Bush or Sec-

retary of State Haig, except that they are in the background along with some advisers. Reagan is laughing, tells jokes and takes pride in his own 'ego' picture of himself as he enters into the election campaign that appears to be more effective after September 1983. Then suddenly there is confusion as I hear, or sense, many guns, grenades and machine guns. A stand and a limousine are riddled and many are killed. I am aware of the same conditions that killed Egypt's president, Sadat. Turmoil, banners are torn down and Reagan is dead. In the vision I saw Bush wearing the Armor of War. That is, as he sits on the throne, he makes war. It is involved in the water sign of Cancer. In the confusion of the vision there appeared to be two assassinations. It may be that Bush will be killed too -- probably after the inauguration. (Shades of George Orwell's "1984"!)

THE PLANNED MILITARY TAKEOVER

"Haig may not be in office; for there is some doubt about his future. It appears that someone else may take his place, and his name might be Brown, who is a five-star general of the U.S. Air Force -- though brown may be a sinister color rather than the name of a person. Either way, Haig is working in the background and a setup is already being made, now."

Charles Marcoux's prophecies are in the February 1982 issue of Mary Martin's "The Hollow Hassle", \$8 a year, PO Box 15198, Colorado Springs, Colorado 80935. He welcomes correspondence with those who send a self-addressed, stamped envelope expecting a reply. A dollar contribution toward office expenses would be welcome, too. His address is PO Box 11494, Phoenix, Ariz. 85061.

One of California's most prominent Fascists, State Senator John Schmitz, revealed the existence of a military takeover scenario back in October 1981, while being interviewed on a Channel 28 television news program and reported in the LA "Times", Oct. 21st: "If President Reagan's foreign and domestic programs fail, the nation will be 'in real bad shape', says Schmitz, 'and the best we could probably hope for is a military coup or something like that.'" Schmitz is a Roman Catholic.

The kind of failure Schmitz is talking about would be a slowing down of the highly profitable nuclear arms race and a nuclear freeze, and Wall Street can indeed keep the nation in "bad shape" with continued high interest rates. As for Army General Haig losing out in the grab for the presidential throne at the time of the planned coup, remember that Satan, an Air Elemental, would be ideologically more comfortable with a General of the U.S. Air Force in the seat of power in Washington. Then Satan could realize His dream of breaking free from the confines of the earth and push His empire out into space. Already an AF General heads NASA, our National Aeronautics and Space Administration, and the billion dollar launching complex at Vandenberg Air Force Base up the coast from us in California is nearly complete and ready for service.

Your ref:

Our ref:

4 Whitchurch Lane
Edgware
Middlesex HA8 6JZ

Price: £33 plus £ postage & packing
\$80 American, plus \$5 for
air mail postage

Tel: 01-952 9566

MAGNAPULSE

The Magnapulse is a small, compact, hand-held instrument, utilising silicon chip technology to generate a very low frequency pulsed magnetic field. It is designed for the treatment of a whole range of complaints and may be found helpful for the following: migraine, asthma, backache, painful joints, headaches, fatigue, rheumatic pains, infections, muscular spasms, etc.

Simply select the required dial setting according to the chart, switch on and place either face of the instrument against the area of pain or discomfort. Treatment time is approximately 15 minutes.

Technical Specifications:

Power supply: 1xPP/3 type 9 volt battery (battery not included)
Current consumption: 8.5mA pulsed
Frequency range: approx. 1-20 Hz in 2 Hz steps (standard model)
Frequency selection: click-stop dial calibrated 0-10
Frequency indication: light-emitting diode
Case dimensions: 104 x 60 x 30 mm
Case colour: black

Chart of suggested use:

Dial No.	Approx. Frequency	
0	1Hz	Infections
1	2Hz	" "
2	4Hz	Soothing effect, muscular spasm
3	6Hz	" " " " "
4	8Hz	Analgesic, tonic
5	10Hz	" " "
6	12Hz	" " "
7	14Hz	In case of over-tiredness these frequencies have the same effect as dial settings 4,5,6.
8	16Hz	
9	18Hz	
10	20Hz	

The last group of frequencies is only used when lower frequencies have had no result. Dial settings 2&3 should not be used whilst engaged in activities which require increased concentration, e.g. driving, operating machinery, etc.

Patients fitted with a Heart Pacemaker should not be treated with the dial set at Nos. 1,2,or3, unless it is known for certain that the pacemaker will not react to the magnetic field.

MORE ON THE TENS or ELF WAVE DEVICES

The English-made **Magnapulse** described on the opposite page and pictured here is not, properly speaking, a TENS (Transcutaneous Electric Nerve Stimulation) device, for it has no electrodes at the ends of flexible wires for making direct contact with the skin. It uses what the electronic technicians call **entrainment**. The gently pulsing magnetic field of the Magnapulse causes the user's aura or magnetic field to resonate or pulse at the same rate. For the person suffering acute and constant pain, this isn't likely to give the quick and sustained relief they are seeking.

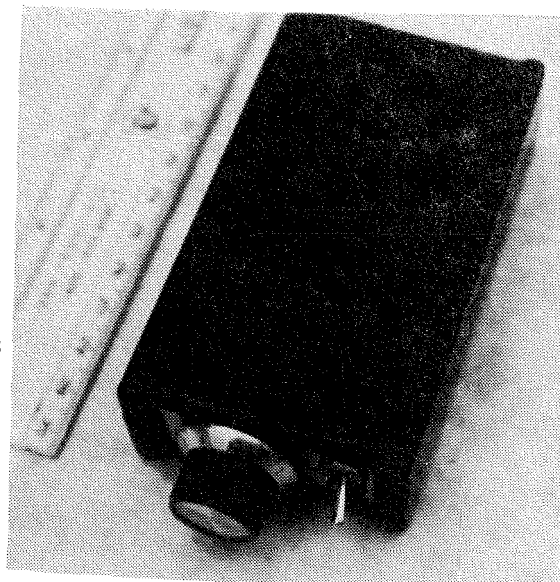

But the effectiveness of specific rates given is the result of years of clinical research in England, stimulated by the pioneering work of W. Grey Walter and the publication of his book, "The Living Brain", published in 1953. Even smaller is Dr. Patrick Flanagan's ERG (Earth Resonance Generator). His ELF wave device costs \$70 and is powered by two 9 volt transistor batteries. It pulses at a fixed rate of around 7 Hertz (cycles per second) close to the Schumann Resonance of the earth's field. It has no switch but runs continuously and is designed to be worn continuously in pocket or purse as a protective device for stabilizing the aura against any and all random or negative vibes of a destructive or harmful nature from outside.

The practical use of ELF waves in therapy was discovered and proven by the American genius, Dr. Albert Abrams, in San Francisco in the 1920s. He was the first to relate diseases to a number system and to electronic circuitry. His Oscilloclast treatment device pulsed with a sharp cutoff at a rate of 90 cycles per minute. That's only $1\frac{1}{2}$ per second, a low ELF rate; but his Oscilloclast was not designed to produce a low-voltage, pain-killing shock of the current TENS devices. A successful Chinese acupuncturist in San Diego, Tomson Liang, has produced a pocket-sized TENS device, sold to his patients for pain control, for \$325. Liang came to America originally, in the early '70s as an electronics engineer for Hughes aerospace industries. His TENS has both rate and volume controls.

Associate Ed Skilling has designed a small TENS, with rate and volume or amplitude controls, also powered with the popular 9 volt transistor battery. His sells for only \$50 and he is willing to share the schematic with us. All of the parts can be obtained from the popular Radio Shack electronic parts stores. We have tried it out ourselves and it works, very well for pain control. It can be used also, without electrodes, for entrainment.

THE TENS BODY-PULSE UNIT, designed by E.E. Skilling

Cost of parts at early 1982 Radio Shack prices about \$15.00. The dot or indentation at one corner of Part No. 555 indicates contact point or post No. 1. #555 is an IC (Integrated Circuit). Tie points 2 and 6 together, and points 4 and 8 together on the IC. The copper side board electrodes are covered with terry cloth sleeves for body contact. These sleeves must be moistened with salt water for good contact with the skin. The 9-volt battery should last for weeks.

Circuit Board Components

- 1 Circuit Board No. 276-024
- 1 555 Timer Integrated Dip
- 1 XFMR Mini Size Coil 8 ohm to 1000 ohm
- 1 100 Ohm Resistor $\frac{1}{2}$ watt
- 2 56K Ohm Resistors $\frac{1}{2}$ watt
- 1 1 MFD Capacitor 50V
- 1 220 MFD Capacitor 16V
- 1 Diode IN 4148 or IN 914
- 1 LED (Light Emitting Diode, to show pulse rate)
- 1 Clip for 9v battery
- Hookup wire and Twin Lead Wire

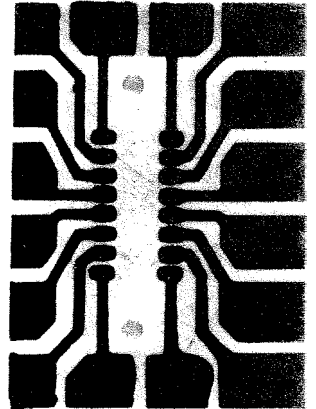

(Circuit Board is notched to make room for the 1 MEG pot)

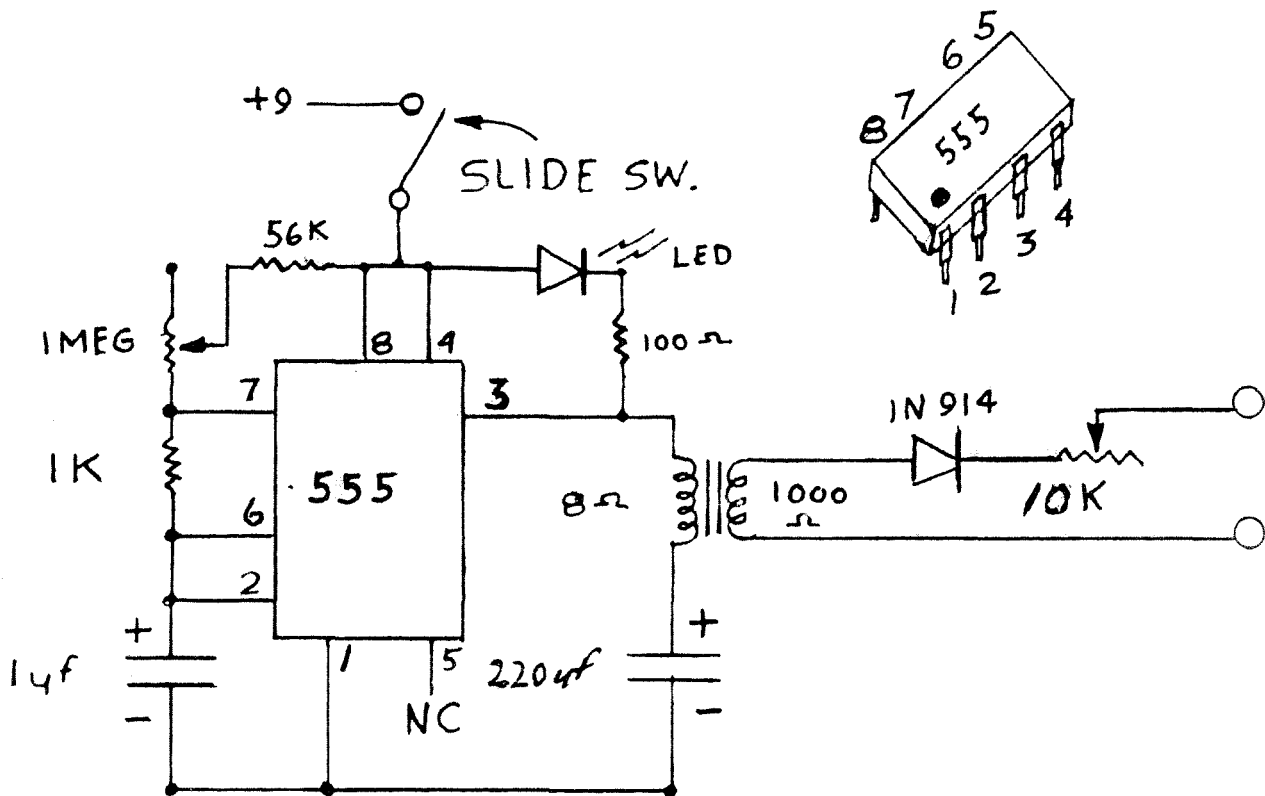

Components Outside of the Circuit Board

- 1 Box, 4½x2½x1 in.
- 2 Metal Posts
- 2 Grommets
- 4 2-56 nuts
- 4 2-56 screws
- 2 Terminal Lugs
- 1 Output Conn. 2 prong
- 1 SPST Min Slide Switch
- 1 1 MEG Pot Linear (Pulse Rate)
- 1 10K Pot Linear (Amplitude)
- 1 9 volt Transistor Battery
- 1 Pc 4' Twin Lead
- 1 Pc #24 Hook-up Wire 1½ ft.
- 2 Dial Knobs, Calibrated
- 2 Pcs 1 in. x 5 in. Double Copper Side Boards (for Electrodes)

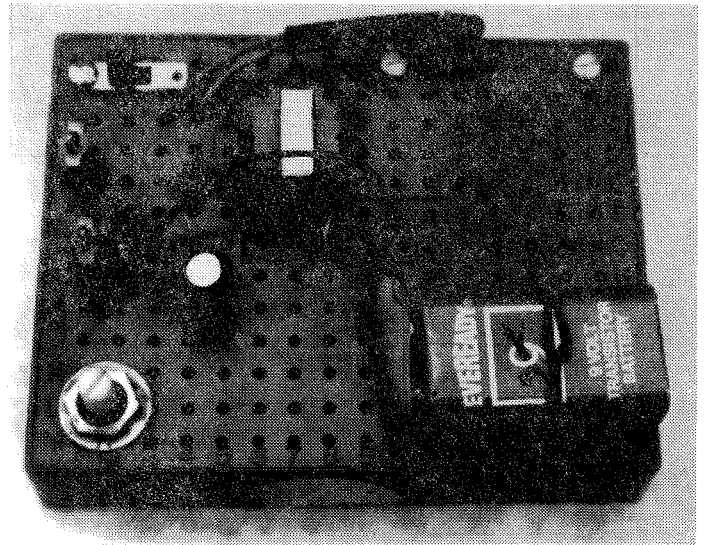

Placement of the Electrodes on the body for most effective results is up to the borderlander researcher. Because the Terry Cloth Electrode sleeves are wet, some kind of water proof covering must be used to keep the day clothing or night clothing from getting wet. An alternative would be to remove the cloth sleeves and coat the body-side of the copper Electrode with electrode gel. This can be obtained from medical and sick room supply stores. They also have the professional, circular type Electrodes for about \$2.50 a pair which can be taped on for one-time use of up to 24 hours.

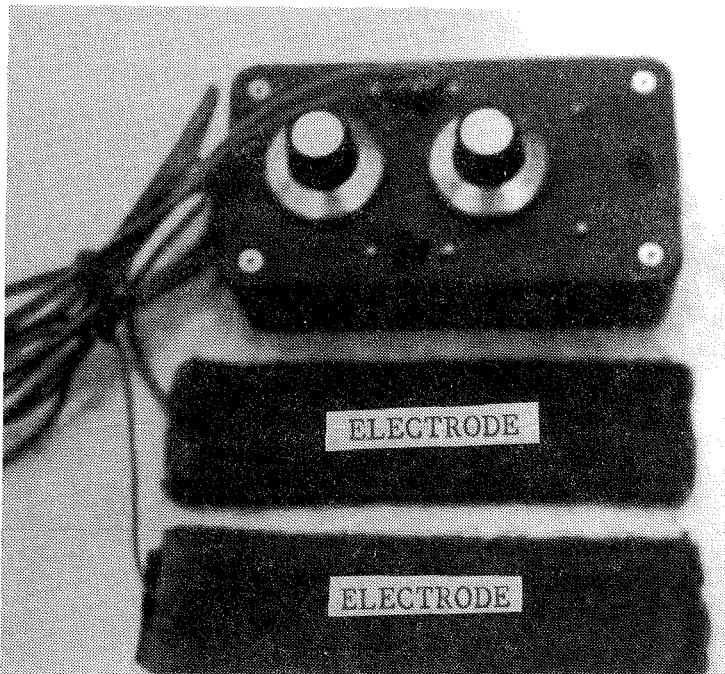

It is best to correspond directly with Ed Skilling about his TENS device, 1750-39 West Citricado Parkway, Escondido, CA 92025, phone 714-743-8931, and learn something of the results of his borderland research with ELF (Extreme Low Frequency Waves) in the past year or so.

Our own ELF wave research has been with a little ELF device kit bought for about \$6 from Radio Shack years ago as an Electronic Metronome! The kit is no longer offered by RS but the parts are easily obtainable there. It has a little 2" speaker for the audio signal and we've added a LED for the visual signal to convince the user that it is working.

ELF WAVE DEVICE, AN ECONOMY MODEL

Radio Shack's Electronic Metronome of the 1970s is a good place to start a simple research program on the effects of ELF

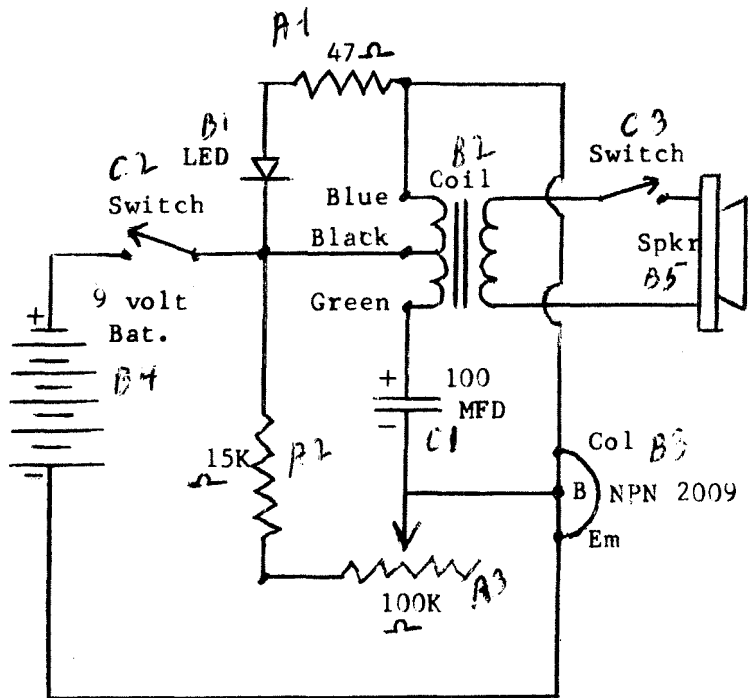

waves (Extreme Low Frequency) on human consciousness. The transistor, B3, sets the coil, B2, to oscillating at low frequencies. These are controlled by the variable capacitor, A3, from about 1 Hertz or cycle per second, to 20 Hertz. The general effects of some of these frequencies are in the Monad literature on page 30 of the this issue. What they don't say is that frequencies of around 7.6 to 8.2 Hertz are said to stimulate ESP.

To calibrate these frequencies accurately you'll have to locate an electronic technician or TV repairman with a High Resolution Frequency Counter and set up a hand drawn dial for A3 marked accordingly.

The B2 coil's pulsations are proven to you visually by the flashing LED light, B1, and by the audio clicks of the little speaker, B5. B2 creates a pulsing electro-magnetic field about 12 to 18 inches in diameter. This is an "automatic pilot" which will entrain your own magnetic aura to oscillating at the same rate, unless you over-ride it with stronger emotional vibes of your own. The Tempic or 4-D effect of B2 flashes outward in all directions at the speed of light. Such a signal speeds around the world in a seventh of a second! So it is a mechanical base for telepathy, if that is your intention.

Flexible, insulated wire leads for body-contact electrodes can be attached to the red and white output leads of B2 which go to the Speaker; however, the current is so weak that it isn't likely you will feel any kind of a shock, as is the case with a true TENS device. A switch, C3, is provided to cut off the audio if you want total silence while concentrating on ESP.

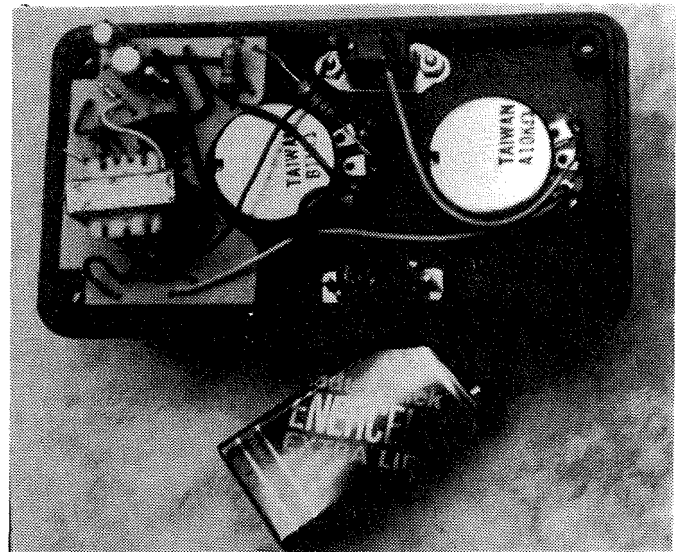

PARTS FOR ELF WAVE METRONOME

A1	47 ohm Resistor, $\frac{1}{2}$ watt	C1	100 MFD Axial Cap. 16 volt
A2	15K ohm Resistor, $\frac{1}{2}$ watt	C2	Sub mini Switch
A3	100K ohm Variable Resistor	C3	" " "
B1	LED Light, Jumbo	1	Prepunched Perf Board
B2	Audio Coil Trans. 1KCT to 8 ohm	1	9 volt Battery Snap
B3	NPN Sil. Transistor #2009	3	4/32 nuts, bolts & washers to hold Spkr in place
B4	9 volt Transistor Battery		#22 Hookup wire, solder, etc.
B5	2 in. Speaker, 8 ohm, .2 Watts		

We are hopeful that Associates will build and experiment with these as consciousness expanders and as entrainment devices for protection against Tamper Rays from outside sources.

NEED SOMETHING ELECTRONIC?

"Or do you have an idea for an electronic device but dont know how to build it? Or do you need electronic advice? Give me a call at 213-782-0820 during the day and I will call you back on my WATS line. My night phone is 213-669-0125. Full confidentiality and free price estimate on any project."

Nils Rognerud, 4747 Fountain Ave.
Los Angeles, California 90029

BY ALL MEANS, PROFESSOR, SPREAD THE BORDERLAND WORD!

"In my physics classes I have talked to my students about the Lakhovsky Multi-Wave Oscillator, Project Hermes (for telepathy, an ELF wave device) and Vitic (carbon and magnet for charging the nerves) and these astounding devices have fascinated them. The same is true for several of my friends, some of them MDs and Physicists. I would like they read these BSRF brochures, however, and most of them do not understand English. So I would like to have your written permission for translating from English into Portuguese these three BSRF brochures. Copies of these would be sent to several hospitals, clinics and Psychic Research Centers."

Prof. Jairto Gomes dos Santos
Sao Paulo, Brasil

THE AF KEEPS IN PRACTICE FOR 1984?

LA "TIMES", April 18, 1982: "A reporter for the National Catholic Reporter in Kansas City said she was held at gunpoint and was forced to lean spread-eagled against a fence for two hours by security guards while she was covering a one-man protest at a White-man Air Force Base missile silo. The Society of Professional Journalists, Sigma Delta Chi, which filed a formal protest of Tuesday's incident, said Penni Crabtree was 'forced to kneel and was kept in that position for about 10 minutes by an Air Force security officer who pointed an M-16 rifle at her head.' The group said Crabtree did not enter restricted areas, trespass or otherwise violate any laws."

May-June 1982 RR, Page 35

REALITY OF THE CAVERN WORLD (BSRF No. 2-E) An illustrated talk about the interior of the earth and those who live in it, by the Director of BSRF. This includes comment and analysis about the following: The Origin of the Serpent Race, Lord Byron's story of a Magickal Ceremony which evoked Cavern elementals and Lucifer himself in an Alpine chalet, the Shaver Mystery and the Deros, the famous Catacomb of Hal Saf- lini on the Island of Malta a Cavern entrance, human dwarfs and 20-ft giants, the Kingdom of Pan -- Fauns and Satyrs, the Planes of Consciousness in the Earth, a Guided Tour Through the Interior, and in conclusion a message from an Earth God. Postpaid. . . \$3.00

TWO INVENTORS RETURN and PROJECT HERMES (BSRF No. 12) The first section is by General Electric engineer and BSRAssociate J. Gilbert E Wright on his psychic contacts with Steinmetz and Edison, trying to gain useful info on construction of a psychic microphone. He was successful after being to incorporate "bouncing putty" in it. Included are sketches of the Edison Psychic mike (unsuccessful) and the Vandermeulin signalling device (successful). The second section of eight pages is on PROJECT HERMES, an ELF wave device (1953) before ELF waves were discovered! Ralph "Rolf Telano" Holland channeled the schematic for Hermes from the Other Side. It, too, uses a pulsing electro-magnetic field to entrain the sending and receiving centers in the brain for telepathy. Hermes parts are not easy to obtain now and current ELF wave devices are probably just as effective. Postpaid. \$3.00

- - - - - CALIFORNIANS ADD 6% SALES TAX - - - - -

The JOURNAL of Borderland Research

Bulk Rate U.S. POSTAGE PAID Vista, Calif. Permit No. 42

A Publication of:
Borderland Sciences
Research Foundation
PO Box 549, Vista,
California USA
92083